

USERS GUIDE **CRYSTAL** PRESENCE SENSOR

PRODUCT DESCRIPTION

The Crystal Active Infrared presence detector (PN: 10CRYSTALPRE) is ideal for threshold safety and sidelite protection for sliding doors, as well as threshold protection on the approach side of a swinging or bi-folding door. It is universally compatible with any automatic door control, and is quick and easy to install. The Crystal technology utilizes multiplexing, which assures that it is constantly scanning the background looking for any changes. Therefore, if the change in background remains constant for a set time (adjustable 1 minute or 10 minutes), the sensor learns it and allows your door to return to normal operation.

NOTE: The Crystal should not be used as a motion detector. The Crystal's detection pattern does not meet the minimum motion pattern requirements as stated by ANSI A156.10.

TECHNICAL SPECIFICATIONS

TECHNICAL SPECIFICATIONS	
Installation Height:	7' to 10'
Detection Zone:	Wide pattern: 6' Narrow pattern: 3' Depth: 4"
Mounting Angle:	from 3° to 21°
Power Supply:	12 to 30 V DC ± 10% 12 to 24 V AC ± 10%
Consumption:	< 1 W (VA)
Output - Contact Ratings:	Dry Contacts
Max. voltage	60 V DC / 125 V AC
Max. current	1 A (resistive)
Max. switching power	30 W (DC) / 60 VA (AC)
Frequency:	50 to 60 Hz
Response Time:	< 50ms
Relay hold time:	1.5 seconds (fixed)
Auto Learn Time	1 or 10 minutes
Temperature range:	-30° to +131° F
Dimensions:	10" L x 2" H x 1.5" D
Weight:	7 oz.
Material:	Black ABS and polycarbonate
Length of Cable:	6'

COMPONENT ID

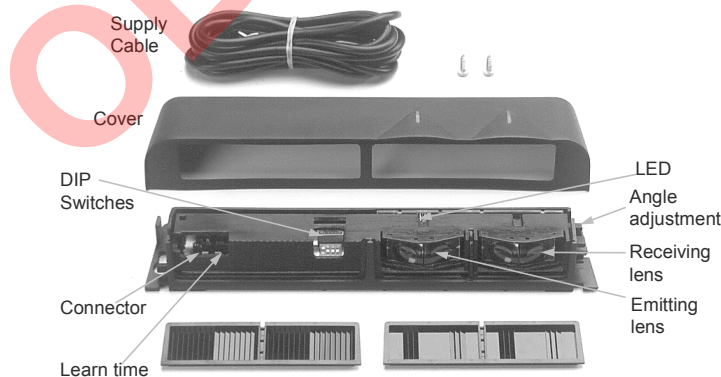

SAFETY PRECAUTIONS

- Shut off all power going to the header before attempting any wiring procedures.
- Maintain a clean & safe environment when working in public areas.
- Constantly be aware of pedestrian traffic around the door area.
- Always stop pedestrian traffic through the doorway when performing testing that may result in unexpected reactions by the door.
- Always check placement of all wiring and components before powering up to insure that moving door parts will not catch any wires and cause damage to equipment.
- Ensure compliance with all applicable safety standards (i.e. ANSI A156.10) upon completion of installation.

**MECHANICAL
INSTALLATION**

1. Remove the cover from the sensor by holding the sensor firmly and gently prying the cover off as shown below.

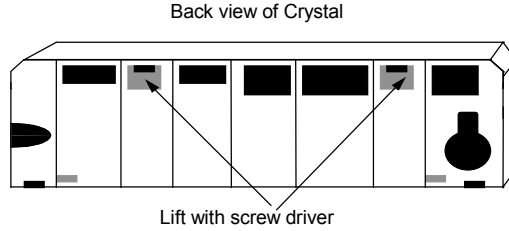

2. Stick the mounting template onto the location where the sensor is to be mounted. Follow the directions provided on the template. When drilling is complete, install both screws part way only. **DO NOT MOUNT SENSOR YET.**
3. Install the cable (included in box). NOTE: If mounting directly to the header, pull the cable through the hole on the face of the header. Leave about 2 to 3 inches hanging out. Connect the JST connector to the Crystal.
4. Place the screw on the right side into the slot on the sensor. Once in place, slide the sensor up so that the screw on the left side slides into the narrow part of the hole on the sensor. Tighten the two screws so that the sensor will not vibrate. Also, ensure that there are no pinched wires between the mounting surface and the back of the sensor.

**ELECTRICAL
INSTALLATION**

1. Connect the wires to power and the door control according to the following color code. BEA, Inc. recommends the use of an isolated transformer to power the sensor.

COLOR	CONNECTION
Red	Supply voltage
Black	Supply voltage
White	RELAY - COM
Green	RELAY - NO/NC (dependent on dip switch 2)

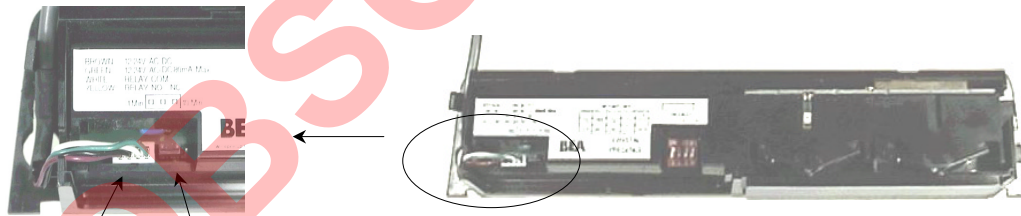

4-Wire Connector Auto-Learn Time Jumper

2. Where the Crystal is wired to on the door control depends on the specific application. For example:
 - a) If the Crystal is installed to provide additional threshold protection, it would normally be connected to the ACTIVATE and COMMON terminals of the door control (see below).
 - b) If the Crystal is installed to protect the sidelites of a sliding door, it could be connected to the SAFETY and COMMON terminals of the door control, or could also be wired to open the activation switch circuit when in detection, but only when the door is fully closed; this method would also require a door position switch as shown on page 3.

THRESHOLD PROTECTION used with a motion detector on a SWINGER or SLIDER:

The Crystal must be wired in (NO & COM) in parallel with the motion detector.

Door Control

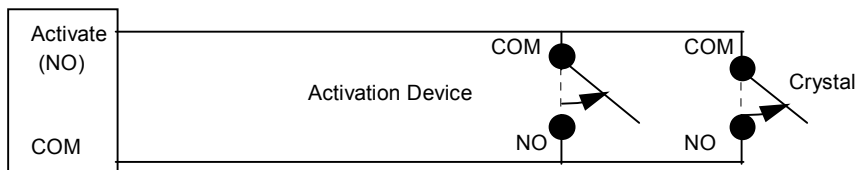

**ELECTRICAL
INSTALLATION –
Cont.**

SIDELITE SAFETY without safety on control.

When using the Crystal for sidelite protection, the crystal's output can NOT control the speed of the door. If the door control is equipped with a safety circuit, the Crystal can be connected to the safety and a creep mode may be achieved if this option is available on the door control.

IF the door control does not have a safety circuit, the crystal still may be used for sidelite protection. However, a creep mode cannot be achieved. The crystal can keep the door closed or open once detection by the crystal has occurred. See the diagrams below for details on wiring a Crystal to a door without safety.

1. If the Crystal is used for sidelite safety on a sliding door, it must be wired (NC & COM) in series with the motion detector. Also, a normally open (NO) door position switch must be wired in parallel with the Crystal in order to allow activation by the motion sensor when the door is other than fully closed and the Crystal is in detection. If the Crystal is in detection while the door is fully closed, the door will not open. When the door is open, only the motion sensor, when in detection, may keep the door open. See schematic below.

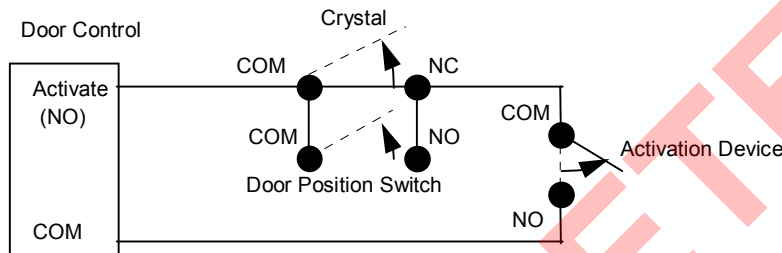

**PATTERN
WIDTH**

Before powering the sensor up, select an appropriate lens, narrow or wide, for the application. By changing the front lens, the pattern width can be made narrow (3') or wide (6'). In order to get the narrow pattern; the scored lens must be placed below the emitter and receiver in the housing. If the wider pattern is desired, the semi-scored lens must be placed below the emitter and receiver in the housing. The lens that is not used, is simply stored in the remaining slot. See the photos below for more detail.

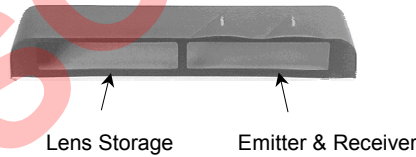

Narrow Pattern (3 foot width)

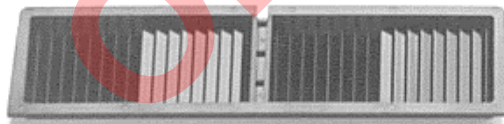

Scored Lens

Wide Pattern (6 foot width)

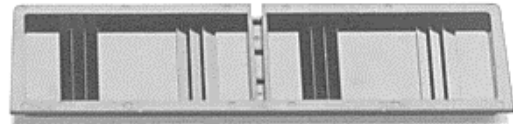

Semi-scored Lens

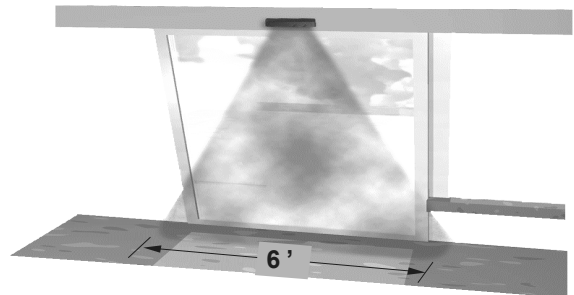
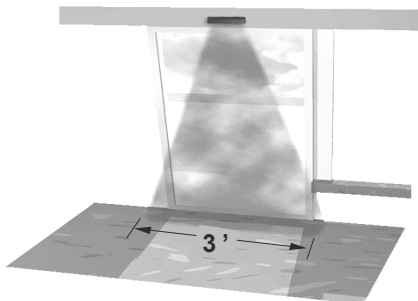

DIP SWITCH SETTINGS

There are 4 dipswitches on the Crystal that must be configured before powering. Use the chart below to help configure the sensor.

Front view of Crystal

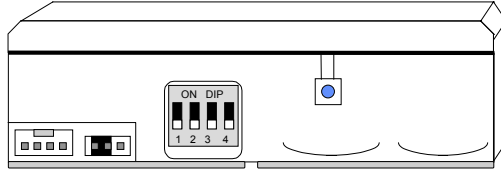

DIPSWITCH	ON	OFF	NOTES
1	Normal Operation	Launch Set-up	To force a set-up of the sensor, simply place the dipswitch OFF, then switch it back to the ON position.
2	Normally Closed	Normally Open	Relay status is reference when sensor is in state of non-detection. Thus, normally open means that the relay will close when the sensor is in detection
3	Frequency 2	Frequency 1	Use Frequency 1 for normal operation Use Frequency 2 to avoid interference between 2 Crystals
4	Reduced Sensitivity	Normal Sensitivity	Use Reduced sensitivity to help eliminate "ghosting", otherwise use normal sensitivity

AUTOMATIC LEARN TIME

The Auto Learn Time is the time in which the Crystal will automatically learn any permanent changes in its field of detection. The time may be set for 1 minute or 10 minutes, and begins counting down once a change in the detection zone occurs. If the object is removed from the zone before the time delay has expired, the Crystal will not save it as part of its memory. During the auto learn time the Crystal will stay locked on and once the Crystal has learned the object it will resume its normal function.

The Auto Learn Time is adjusted by changing a jumper located near the plug connector as shown below.

1 minute =



10 minutes =



POWERING THE SENSOR

Upon supplying power to the Crystal (12 to 30 V DC \pm 10% or 12 to 24 V AC \pm 10%), the following should be observed:

- The Red LED on the front of the sensor will illuminate immediately upon powering the sensor
- Insure that the field of detection remains uninterrupted while the Red LED is on.
- After approximately 6 seconds, the Red LED should go out
- Walk-test the sensor to check the width and the depth of the field of detection
- Make changes to the field of detection as necessary
- Proceed to next section for instruction on how to adjust the angle of detection

ADJUSTING THE ANGLE OF THE DETECTION FIELD

- Once the sensor is powered and is working normally, the position of the detection field may be adjusted. To change the angle of detection, insert a screwdriver into the recess on the extreme right-hand side of the sensor. Turn it slightly to select the required tilt angle. The angle may be adjusted from 3° to 21°, and the resulting field is shown in the diagram below.

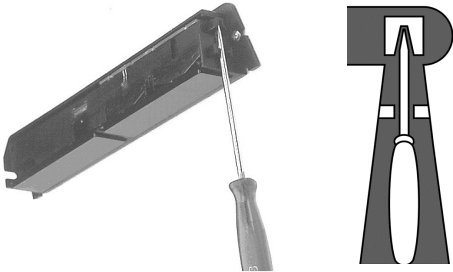

NOTE: The distance of detection from the door will increase as the mounting height of the Crystal is increased. It will also decrease as the mounting height of the Crystal is decreased. ALWAYS be sure to walk-test the door upon completion of all sensor adjustments, to insure compliance with applicable safety standards (i.e. ANSI A156.10).

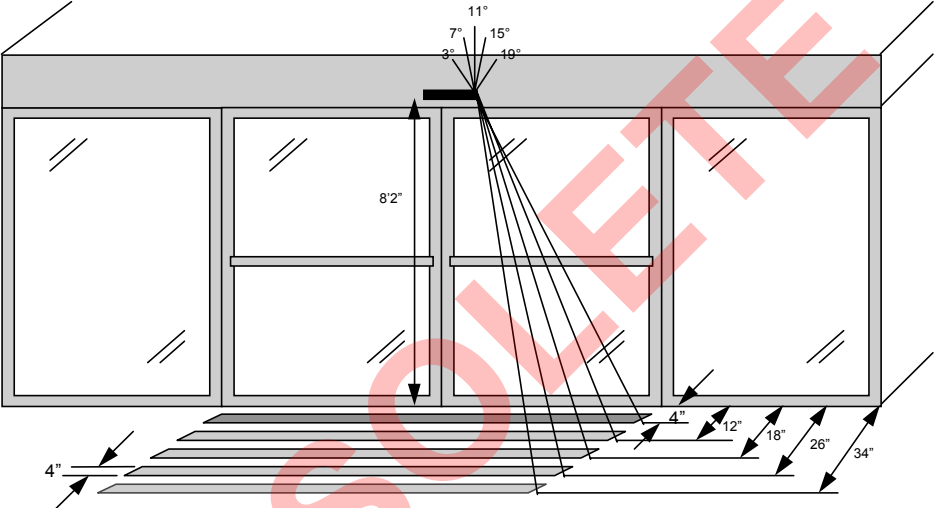

- When the installation is complete, re-install cover. Make sure the cable is routed around the plastic post to help prevent water from entering the sensor. Install Cover.

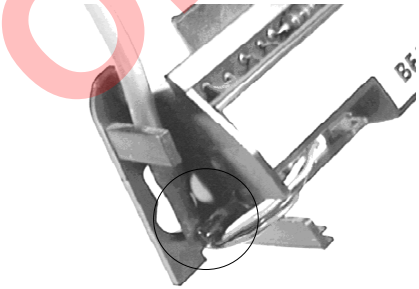

TROUBLE – SHOOTING

SYMPTOM	CORRECTIVE ACTION
The LED does not light up	<ol style="list-style-type: none"> 1. Check power cable 2. Check power connector 3. Check power supply
The door opens and closes continuously	<ol style="list-style-type: none"> 1. Increase angle of detection (sensor may be seeing the door movement) 2. Switch dip switch # 4 to ON position (reduced sensitivity) 3. Switch dip switch #1 to OFF position and then back to ON position

ACCESSORIES



PN: 10URC
Universal Rain Cover



PN: 10CCA
Crystal Ceiling Adaptor

COMPANY
CONTACT

If after troubleshooting a problem, a satisfactory solution cannot be achieved, please call B.E.A., Inc. for further assistance during **Eastern Standard Time at 1-800-523-2462 from 8am - 5pm.** For after-hours, call East Coast: 1-866-836-1863 or 1-800-407-4545 / Mid-West: 1-888-308-8843 / West Coast: 1-888-419-2564. **DO NOT leave any problem unresolved.** If you must wait for the following workday to call B.E.A., leave the door inoperable until satisfactory repairs can be made.
NEVER sacrifice the safe operation of the automatic door or gate for an incomplete solution.
Web: www.beasensors.com

OBSOLETE