

BR2-900

2-Relay Logic Module with Built-In
900 MHz Wireless Technology

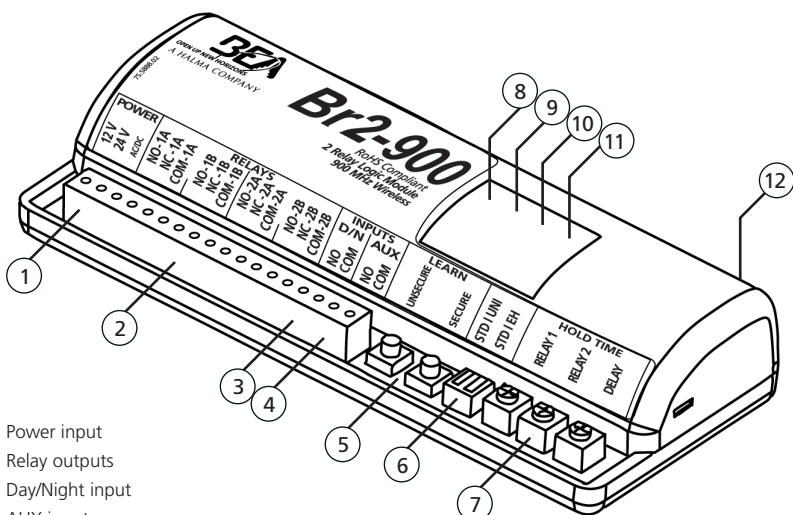

Visit website for
available languages of
this document.



1. Power input
2. Relay outputs
3. Day/Night input
4. AUX input
5. Learn buttons
6. DIP-switches
7. Potentiometers
8. Radio frequency LED (red)
9. Relay 2 LED (white)
10. Relay 1 LED (blue)
11. Tri-color signal strength LED
12. Antenna

HANDHELD TRANSMITTERS



10TD900HH1
1-button transmitter



10TD900HH2
2-button transmitter



10TD900HH3
3-button transmitter



10TD900HH4
4-button transmitter

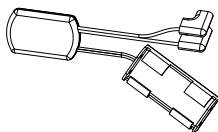

10TD900PB
Push Plate transmitter



10TD900TR
Touchless Retrofit transmitter



10TD900HH1U
1-button Universal transmitter

PRECAUTIONS



- ❑ Shut off all power going to header before attempting any wiring procedures.
- ❑ Maintain a clean and safe environment when working in public areas.
- ❑ Constantly be aware of pedestrian traffic around the door area.
- ❑ Always stop pedestrian traffic through the doorway when performing tests that may result in unexpected reactions by the door.
- ❑ ESD (electrostatic discharge): Circuit boards are vulnerable to damage by electrostatic discharge. Before handling any board, ensure you dissipate your body's ESD charge.
- ❑ Always check placement of all wiring before powering up to ensure that moving door parts will not catch any wires and cause damage to equipment.
- ❑ Ensure compliance with all applicable safety standards (e.g. ANSI A156.10) upon completion of installation.
- ❑ DO NOT attempt any internal repair of the components. All repairs and/or component replacements must be performed by BEA, Inc. Unauthorized disassembly or repair may:
 1. jeopardize personal safety and may expose one to the risk of electrical shock.
 2. adversely affect the safe and reliable performance of the product resulting in a voided warranty.

INSTALLATION

Wiring

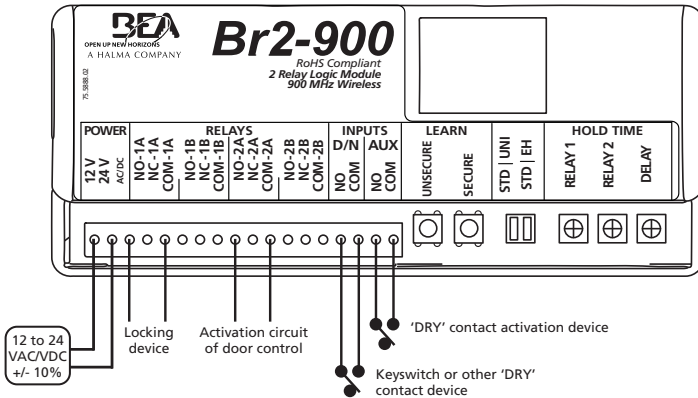

Relay 1 is a dry output. The BR2-900 does not provide power to the locking device; power to the locking device must be provided separately.

Relays 1 and 2 are DPDT: relays **1A and 1B** fire simultaneously and relays **2A and 2B** fire simultaneously.

Relays **1B and 2B** are commonly used in applications with two (2) locking devices and/or with two (2) independent door controls.

INPUT D/N (DAY/NIGHT mode)

when open, allows transmitters learned in both SECURE mode and UNSECURE mode to function
when closed, only allows transmitters learned in UNSECURE mode to function

INPUT AUX functions regardless of learn, DIP switch, or potentiometer settings.

USER INTERFACE

DIP Switches

DIP switches can be set to achieve desired functionality based upon specific application requirements.

DIP	STATUS	FUNCTION	DESCRIPTION
1	STD	standard mode	allows only learned/programmed transmitters to function
	UNI ¹	universal mode ²	allows learned/programmed and "universal transmitters" to function
2	STD	standard mode	pressing/holding or pressing/releasing transmitter activates and holds relay according to HOLD TIME POTs (single shot)
	EH	extended hold	pressing/holding transmitter holds relay as long as transmitter is pressed/ held – once released, relay acts according to HOLD TIME POTs

NOTES:

1. Day/Night mode does not function when DIP-switch 1 is set to UNI.
2. See Universal Mode in SETUP section (page 5).

Learn Buttons

900 MHz wireless transmitters can be programmed (or "learned") as either UNSECURE or SECURE transmitters. Any combination of up to 75 transmitters may be programmed.

BUTTON	FUNCTION	DESCRIPTION
UNSECURE	unsecure transmitters	learned transmitter functions when INPUT D/N is open or closed
SECURE	secure transmitters	learned transmitter only functions when INPUT D/N is open

Potentiometers

Potentiometers control output relay functionality.

POT	FUNCTION	DESCRIPTION
HOLD 1	relay 1 hold time	0.5 – 10 seconds
HOLD 2	relay 2 hold time	0.5 – 10 seconds
DELAY	delay between relay 1 and relay 2	0 – 30 seconds

Signal Strength Indicator

Pressing and holding transmitter button for three (3) seconds activates signal strength LED on BR2-900.

LED COLOR	DESCRIPTION
GREEN	strong wireless signal
YELLOW	moderate wireless signal
RED	weak wireless signal

Handheld Transmitter Configuration

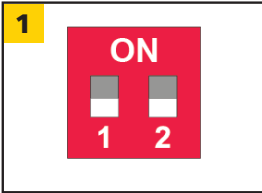

Set DIP switches as desired.
For DIP switch settings, please refer to table on page 3.

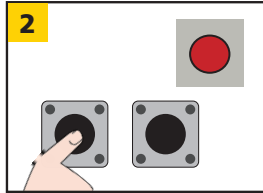

Press and release desired Learn button (red LED on BR2-900 will illuminate).

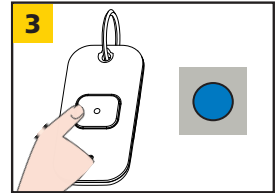

Press transmitter twice (white and blue LEDs on receiver will illuminate).

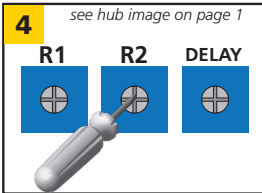

Adjust POTs as desired.
See page 3 for descriptions.

Push Plate Configuration

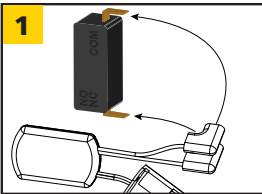

Connect transmitter¹ to push plate (NO and COM) and insert into box.

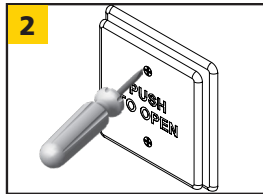

Install push plate.

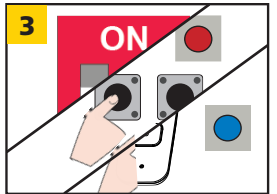

Follow steps 1 – 4 in *Handheld Transmitter Configuration* above.

NOTES:

- 1. 10TD900PB required for push plates.

Universal Mode

Universal transmitters (10TD900HH1U) do not need programmed (or "learned") to the BR2-900. Their unique serial number is automatically recognized by the BR2-900.

During the Handheld Transmitter Configuration or the Push Plate Configuration steps (above), standard transmitters must be programmed/learned as either "Secure" or "Unsecure" transmitters. When set to Universal, learned, standard transmitters will function as programmed/learned.

Simultaneous pair with independent controls

Door 1 and Door 2 will open simultaneously.

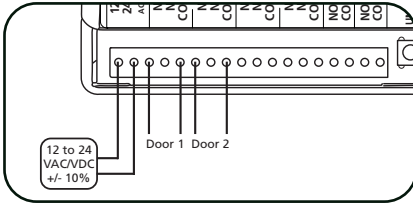

Simultaneous pair with independent controls and electric exit devices powered from a power supply

Example: Relay 1 to trigger the electric exit device power supply; Relay 2 to activate controls.

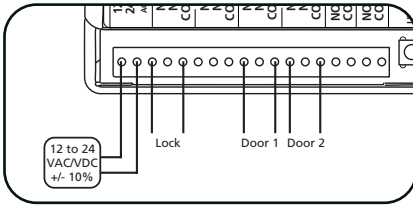

Pair of doors with independent controls and an astragal

Door 1 will open and then Door 2 will open after a delay set by DELAY POT.

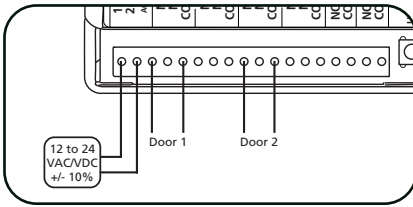

Pair of doors with MAGLOCKS and independent controls

MAGLOCKS will drop simultaneously and doors will open after a delay set by DELAY POT.

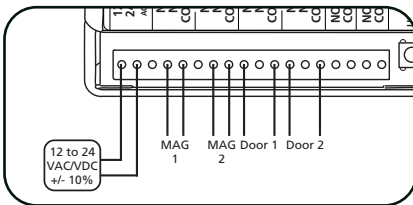

REMOVING TRANSMITTERS

Single Transmitter

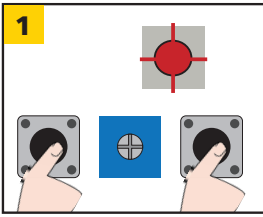

Press BOTH learn buttons until red LED flashes once (~2 s).

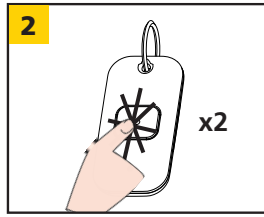

Press transmitter TWICE within 10 seconds.

All Transmitters

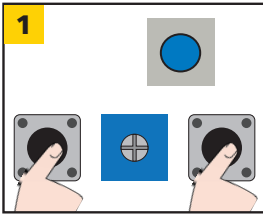

Press BOTH Learn buttons until blue LED illuminates (~10 s).

BATTERY REPLACEMENT

Handheld Transmitter (TD900HHx)

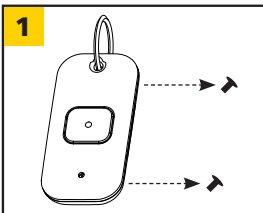

Remove back screws and disassemble.

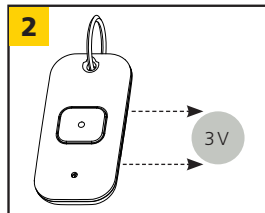

Replace 3 volt (CR2032) battery observing polarity and reassemble.

Push Plate (TD900PB)

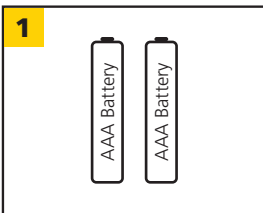

Replace 2 AAA batteries observing polarity.

Low Battery Indicator:

After transmitter button is pressed, low battery is indicated by three (3) transmitter red LED blinks.

TROUBLESHOOTING

BR2-900 will not react to any inputs	Incorrect power	Verify power supply of 12 – 24 VAC/VDC $\pm 10\%$ is wired to correct terminals.
	Not programmed	Ensure a BR2-900 is programmed with wireless transmitter.
	Incorrect wiring	Verify wiring.
	Defective BR2-900	Replace BR2-900.
BR2-900 has no output	Incorrect output devices	Ensure proper devices are connected to outputs.
	Incorrect wiring	Verify wiring.
	Incorrect settings	Verify programming and potentiometer settings.
	Defective BR2-900	Replace BR2-900.
 Red LED on receiver flickering; unable to program	Push Plate is stuck	Disconnect push plates to determine which one is stuck (LED should go out).
	Faulty transmitter	If LED does not go out, remove transmitter batteries to determine which is faulty, replace transmitter.
Weak signal	Antenna positioned poorly	Position antenna outside of door header.

Can't find your answer?
Visit www.beainc.com or scan QR code
for Frequently Asked Questions!



TECHNICAL SPECIFICATIONS

Supply voltage	12 – 24 VAC/VDC $\pm 10\%$
Current consumption	45 mA DC 75 mA AC
Frequency	908 – 918 MHz (frequency hopping)
Emitted radio power	-25 dBm (TX)
Power consumption	0.5 – 1.5 W
Transmitter capacity (per receiver)	
programmable (standard)	75
universal	unlimited
Temperature rating	-22 – 158 °F (-30 – 70 °C)
Input	
Day / Night (24hr)	DRY contact
AUX	DRY contact
Contact rating	Relay 1 DPDT / Relay 2 DPDT 2 A @ 30 VDC or 2 A @ 24 VAC
LEDs	blue = relay 1 activation white = relay 2 activation red = radio frequency / learn tri-color = signal strength
Certification	FCC, IC
Dimensions	5.2" (W) x 1" (H) x 2.2" (D) (133 mm x 25 mm x 55 mm)
Housing	ABS (white translucent)

Specifications are subject to change without prior notice.
All values measured in specific conditions.

“This device complies with Part 15 of the FCC Rules. Operation is subject to the following two conditions: (1) this device may not cause harmful interference, and (2) this device must accept any interference received, including interference that may cause undesired operation.”

Changes or modifications not expressly approved by BEA Incorporated could void the user’s authority to operate the equipment.

Note: This equipment has been tested and found to comply with the limits for a Class A digital device, pursuant to part 15 of the FCC Rules. These limits are designed to provide reasonable protection against harmful interference when the equipment is operated in a commercial environment. This equipment generates, uses, and can radiate radio frequency energy and, if not installed and used in accordance with the instruction manual, may cause harmful interference to radio communications. Operation of this equipment in a residential area is likely to cause harmful interference in which case the user will be required to correct the interference at his own expense.

This device complies with Industry Canada licence-exempt RSS standard(s). Operation is subject to the following two conditions: (1) this device may not cause interference, and (2) this device must accept any interference, including interference that may cause undesired operation of the device.

Le présent appareil est conforme aux CNR d’Industrie Canada applicables aux appareils radio exempts de licence. L’exploitation est autorisée aux deux conditions suivantes : (1) l’appareil ne doit pas produire de brouillage, et (2) l’utilisateur de l’appareil doit accepter tout brouillage radioélectrique subi, même si le brouillage est susceptible d’en compromettre le fonctionnement.

FCC ID: 2ABWS-10BR2900	IC: 4680A-10BR2900	MODEL: 10BR2900
FCC ID: 2ABWS-10TD900PB	IC: 4680A-10TD900PB	MODEL: 10TD900PB
FCC ID: 2ABWS-10TD900HH4	IC: 4680A-10TD900HH4	MODEL: 10TD900HH1
FCC ID: 2ABWS-10TD900HH4	IC: 4680A-10TD900HH4	MODEL: 10TD900HH2
FCC ID: 2ABWS-10TD900HH4	IC: 4680A-10TD900HH4	MODEL: 10TD900HH3
FCC ID: 2ABWS-10TD900HH4	IC: 4680A-10TD900HH4	MODEL: 10TD900HH4
FCC ID: 2ABWS-10TD900HH1U	IC: 4680A-10TD900HH1U	MODEL: 10TD900HH1U

BEA, INC. INSTALLATION/SERVICE COMPLIANCE EXPECTATIONS

BEA, Inc., the sensor manufacturer, cannot be held responsible for incorrect installations or incorrect adjustments of the sensor/device; therefore, BEA, Inc. does not guarantee any use of the sensor/device outside of its intended purpose.

BEA, Inc. strongly recommends that installation and service technicians be AAADM-certified for pedestrian doors, IDA-certified for doors/gates, and factory-trained for the type of door/gate system.

Installers and service personnel are responsible for executing a risk assessment following each installation/service performed, ensuring that the sensor/device system performance is compliant with local, national, and international regulations, codes, and standards.

Once installation or service work is complete, a safety inspection of the door/gate shall be performed per the door/gate manufacturer’s recommendations and/or per AAADM/ANSI/DASMA guidelines (where applicable) for best industry practices. Safety inspections must be performed during each service call – examples of these safety inspections can be found on an AAADM safety information label (e.g. ANSI/DASMA 102, ANSI/DASMA 107, UL294, UL325, and International Building Code).

Verify that all appropriate industry signage, warning labels, and placards are in place.

