

FOCUS and FOCUS 2

Presence sensors for revolving doors, drive-up windows, and sidelite protection



Visit website for available languages of this document.

DESCRIPTION

FOCUS (surface mount)

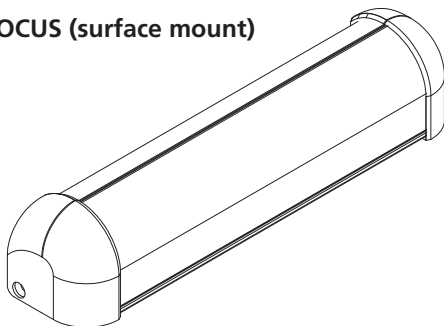

FOCUS 2 (recessed mount)

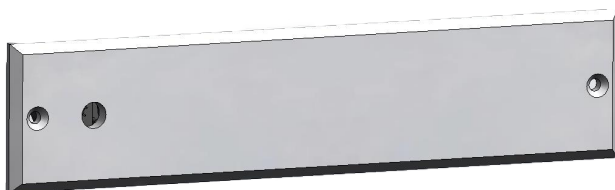

TECHNICAL SPECIFICATIONS

Technology	active infrared
Detection mode	infinite presence detection by distance measurement (N.O. or N.C.)
Detection field	0 – 8' 2"
Response time	< 50 ms
Supply voltage	24 VAC/VDC +10%
Max. current consumption	on = 60 mA; off = 30 mA
Standard output: max. contact rating	relay 1A @ 30 V (resistive)
Distance adjustment	2 – 8' (rotating cam with linear adjustment)
LED indications:	green = no detection
Temperature range	-30 – 140 °F
PCB dimensions	6 ¾" (L) x 1 ½" (H)
Cable	5-conductor

*Specifications are subject to change without prior notice.
All values measured in specific conditions.*

READ BEFORE BEGINNING INSTALLATION/PROGRAMMING/SET-UP

PRECAUTIONS



CAUTION

- ❑ Shut off all power going to header before attempting any wiring procedures.
- ❑ Maintain a clean and safe environment when working in public areas.
- ❑ Constantly be aware of pedestrian traffic around the door area.
- ❑ Always stop pedestrian traffic through the doorway when performing tests that may result in unexpected reactions by the door.
- ❑ **ESD (electrostatic discharge):** Circuit boards are vulnerable to damage by electrostatic discharge. Before handling any board, ensure you dissipate your body's ESD charge.
- ❑ Always check placement of all wiring before powering up to ensure that moving door parts will not catch any wires and cause damage to equipment.
- ❑ Ensure compliance with all applicable safety standards (i.e. ANSI A156.10) upon completion of installation.
- ❑ **DO NOT** attempt any internal repair of the components. All repairs and/or component replacements must be performed by BEA, Inc. Unauthorized disassembly or repair:
 1. May jeopardize personal safety and may expose one to the risk of electrical shock.
 2. May adversely affect the safe and reliable performance of the product resulting in a voided warranty.

INSTALLATION

FOCUS

1. Remove end caps and lens from the sensor.
2. Drill mounting holes in the extrusion near the ends of the housing.
See image (right) for mounting hole location.
3. Hold the extrusion in the desired mounting location and mark for pilot holes.
4. Drill pilot holes.
5. Mount sensor using provided screws.
6. Plug harness into the 5 pin connector and wire to the control using the table below for reference.
7. Carefully route the harness out of the housing.

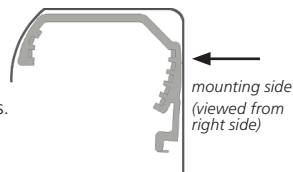

External routing: Use the breakaway notch in the end cap.

Internal routing: Route neatly under end cap.

8. Replace lens and end caps.

FOCUS 2

1. Using mounting template 75.5941, cut hole in desired mounting location.
2. Mount sensor using provided screws. *Observe orientation when inserting sensor. Emitter (TX, below) must be toward vertical stile of the revolving door.*
3. Plug harness into the 5 pin connector. Carefully route harness and wire to the control using the table below for reference.

DIAGRAMS

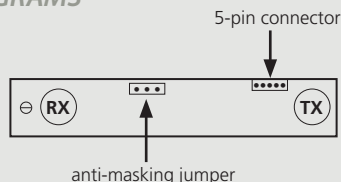

WIRE COLOR	CONNECTION
green	N.O. relay
yellow	N.C. relay
white	COM relay
red	24 VAC/VDC
black	24 VAC/VDC

ANTI-MASKING (see diagram above, right)

ON (factory default): detection occurs even if receiver collects no signal

OFF: no detection occurs if the receiver collects no signal



DETECTION DISTANCE ADJUSTMENTS

1. Use a white, gray, or black piece of cardboard about 8" × 11" and hold it as shown in the diagram.
2. Move the cardboard upward from the floor until it is detected.
3. Measure the height at which the cardboard was detected. This will determine the height of the inactive zone (Y distance).
4. If this height is not between 12" and 16" above the floor or it does not meet your requirements, an adjustment must be made to the detection distance. See diagram below for distance adjustment potentiometer location.
Note: Access the potentiometer on the FOCUS 2 by removing the hole plug on the front face.

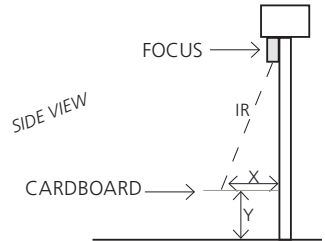

- a. Inactive zone too high: Turn the distance potentiometer **clockwise** to increase the detection distance
- b. Inactive zone too low: Turn the distance potentiometer **counter-clockwise** to decrease the detection distance.

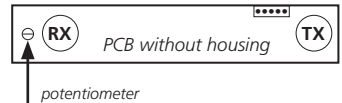

One notch of the distance adjustment corresponds to approximately 4".

5. Repeat this procedure until the desired distance is achieved.

Steps 6 and 7 apply to the FOCUS only.

6. Make sure that the door opens completely to ensure that the detector does not trip when there is no obstacle.
7. If there is detection, turn the distance adjustment counter-clockwise 1 to 2 notches OR change the lateral position of the module OR modify the angle adjustment of the lens.

FOCUS ANGLE ADJUSTMENTS

DOES NOT APPLY TO FOCUS 2

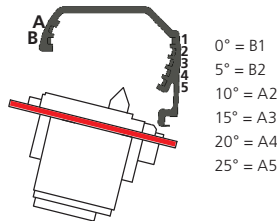

INACTIVE ZONE (Y, below) DISTANCE FROM FLOOR	FOCUS ANGLE					
	0°	5°	10°	15°	20°	25°
8"	0	6"	12 1/2"	19 1/4"	26"	33 1/4"
12"	0	6"	12"	18"	24 1/2"	31 1/2"
16"	0	5 1/2"	11 1/4"	16 3/4"	23 1/4"	29 1/2"
20"	0	5 1/4"	10 1/2"	16"	21 1/2"	27 1/2"

BEA, INC. INSTALLATION/SERVICE COMPLIANCE EXPECTATIONS

BEA, Inc., the sensor manufacturer, cannot be held responsible for incorrect installations or incorrect adjustments of the sensor/device; therefore, BEA, Inc. does not guarantee any use of the sensor/device outside of its intended purpose.

BEA, Inc. strongly recommends that installation and service technicians be AAADM-certified for pedestrian doors, IDA-certified for doors/gates, and factory-trained for the type of door/gate system.

Installers and service personnel are responsible for executing a risk assessment following each installation/service performed, ensuring that the sensor/device system performance is compliant with local, national, and international regulations, codes, and standards.

Once installation or service work is complete, a safety inspection of the door/gate shall be performed per the door/gate manufacturer's recommendations and/or per AAADM/ANSI/DASMA guidelines (where applicable) for best industry practices. Safety inspections must be performed during each service call – examples of these safety inspections can be found on an AAADM safety information label (e.g. ANSI/DASMA 102, ANSI/DASMA 107, UL294, UL325, and International Building Code).

Verify that all appropriate industry signage, warning labels, and placards are in place.

