

# IXIO-DT1 V

## MOTION AND PRESENCE SENSOR WITH CAMERA FOR SLIDING DOORS

Software version 6.3 / Configuration 42.4463.03  
(refer to Admin menu for product software version)



Visit website for available languages of this document.



Available on the **App Store** and **Google play**.  
Download the BEA DECODER app for a quick overview of settings

### WHAT'S IN THE BOX

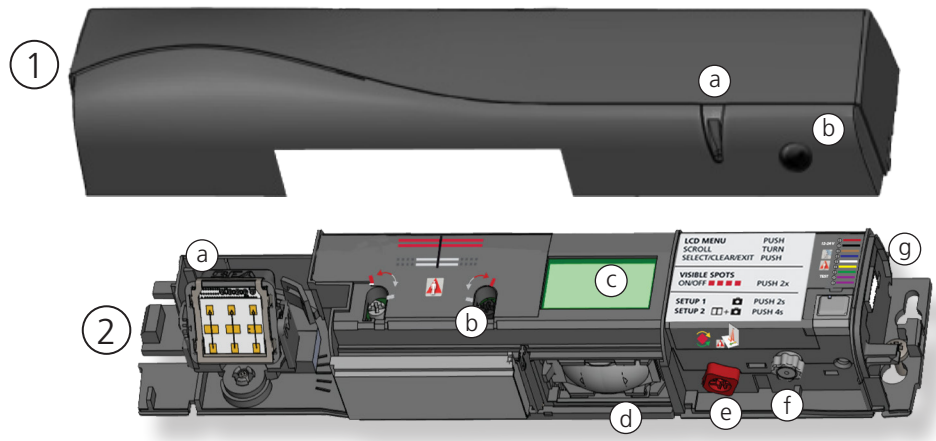

1. cover (10.1279 + 20.2009 cable)
  - a. LED window
  - b. camera
2. sensor (10IXIODT1)
  - a. radar antenna
  - b. AIR curtain width adjustment
  - c. LCD
  - d. AIR lenses
  - e. AIR curtain angle adjustment knob
  - f. main adjustment knob
  - g. main connector
3. harness (20.5349)
4. camera harness (20.2009)
5. screw kit (50.1818)
6. User's Guide (75.5816)
7. Quick Guide (75.1220)
8. Mounting Template (75.0128)

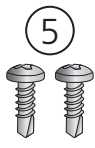
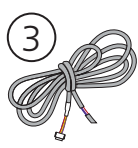

## INSTALLATION



The sensor should be mounted securely to avoid extreme vibrations.

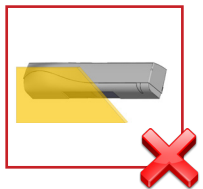

Do not cover the sensor.



Avoid moving objects and light sources in the detection field.



Avoid highly reflective objects in the infrared field.

## MAINTENANCE

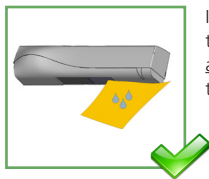

It is recommended to clean the optical parts at least once a year or more if required due to environmental conditions.



Do not use aggressive products to clean the optical parts.

## SAFETY

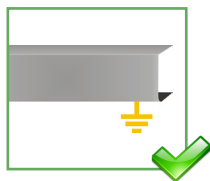

The door control unit and the header cover profile must be correctly grounded.



Only trained and qualified personnel are recommended for installation and setup of the sensor.

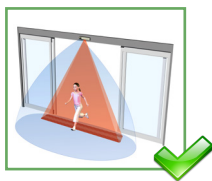

Following installation, always test for proper operation (according to ANSI 156.10) before leaving the premises.

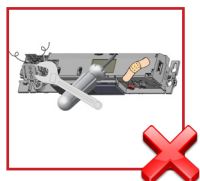

The warranty is invalid if unauthorized repairs are made or attempted by unauthorized personnel.

*This device can be expected to comply with Part 15 of the FCC Rules, provided it is assembled in exact accordance with the instructions provided with this kit. Operation is subject to the following conditions: (1) this device may not cause harmful interference, and (2) this device must accept any interference received, including interference that may cause undesired operation.*

### BEA, INC. INSTALLATION/SERVICE COMPLIANCE EXPECTATIONS

BEA, Inc., the sensor manufacturer, cannot be held responsible for incorrect installations or incorrect adjustments of the sensor/device; therefore, BEA, Inc. does not guarantee any use of the sensor/device outside of its intended purpose.

BEA, Inc. strongly recommends that installation and service technicians be AAADM-certified for pedestrian doors, IDA-certified for doors/gates, and factory-trained for the type of door/gate system.

Installers and service personnel are responsible for executing a risk assessment following each installation/service performed, ensuring that the sensor/device system performance is compliant with local, national, and international regulations, codes, and standards.



Once installation or service work is complete, a safety inspection of the door/gate shall be performed per the door/gate manufacturer's recommendations and/or per AAADM/ANSI/DASMA guidelines (where applicable) for best industry practices. Safety inspections must be performed during each service call – examples of these safety inspections can be found on an AAADM safety information label (e.g. ANSI/DASMA 102, ANSI/DASMA 107, UL294, UL325, and International Building Code).

Verify that all appropriate industry signage, warning labels, and placards are in place.





## TECHNICAL SPECIFICATIONS

### TECHNOLOGY / PERFORMANCE

<b>Detection mode:</b>	Motion minimum detection speed: 2 in/s		Presence typical response time: < 200 ms (max: 500 ms)	
<b>Technology:</b>	Microwave doppler radar Transmitter frequency: 24.150 GHz Transmitter radiated power: < 20 dBm EIRP Transmitter power density: < 5 mW/cm <sup>2</sup>		Active infrared with background analysis Spot: 2" x 2" (typ) Number of spots: max. 24 per curtain Number of curtains: 2	
<b>Mounting height:</b>	6'6" – 11'6" local regulations may impact acceptable mounting height (pedestrian applications only)			
<b>Sensor temperature range:</b>	-13 – 131 °F * 0 – 95% relative humidity, non-condensing  LCD screen is operational from 14 – 131 °F. The sensor may still be programmed in colder temperatures, but with the remote control.			

### ELECTRICAL

#### Output:

<b>Relay 1</b> 	Electromechanical relay (potential and polarity free) Max. contact current: 1 A Max. contact voltage: 30 VAC Adjustable hold time: 0.5 – 9 s
<b>Relay 2</b> 	Solid-state relay (potential and polarity free) Max. contact current: 100 mA Max. contact voltage: 42 VDC / 30 VAC

<b>Test/Monitoring input:</b>	Sensitivity: Low: < 1 V High: > 10 V (max. 30 V)  Response time on test request: typical < 5 ms
-------------------------------	---

<b>Supply voltage:</b>	12 – 24 VAC ±10% 12 – 30 VDC ±10%  to be operated from SELV-compatible power supplies only
------------------------	---

<b>Power consumption:</b>	< 2.5 W
---------------------------	---------

<b>Noise:</b>	< 70 dB
---------------	---------

### CAMERA

Voltage regulator (built into wire harness): 6.6 – 36 VDC (±10%), 6 – 28 VAC (±10%)	
Operating temperature: -22 – 140 °F (max. RH: 95%)	Video output: 1.0 (Vp-p) / 75Ω
Image Sensor: CMOS	Horizontal resolution: 480 TVL
NTSC output: 720 (H) x 480 (V)	Sync system: Inter-Sync
Frame rate: 30 fps	Minimum illumination: 0.01 LUX
AE control: auto	Gain control: auto
Electronic shutter: 1 s ~ 1/10,000s	S/N ratio: > 50 dB
AWB: Auto	

### PHYSICAL

<b>Degree of protection:</b>	IP54
------------------------------	------

### COMPLIANCE

<b>FCC certification:</b>	FCC: G9B-100606 IC: 4680A-100606
---------------------------	-------------------------------------

<b>Compliance:</b>	ISO 13849 PL «C» CAT. 2 (under the condition that the door control system monitors the sensor at least once per door cycle)
--------------------	--

*Specifications are subject to change without prior notice.  
All values measured in specific conditions.*

# HOW TO USE THE LCD

## DISPLAY DURING NORMAL FUNCTION

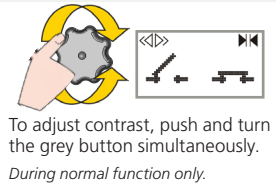
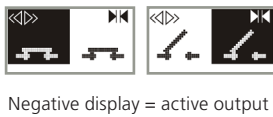
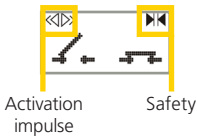

## FACTORY VALUE VS. SAVED VALUE

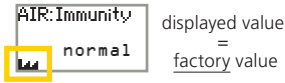

## NAVIGATING IN MENUS

- 1) Push to enter the LCD menu. 2) Enter password, if necessary. 3) Select language before entering the first LCD menu.



Not during the first minute after power-on of the sensor.



During the first 30 seconds after power-on of the sensor or later in the diagnostics menu.

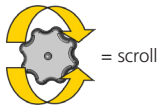

Select **Back** to return to previous menu or display.

Select **More** to go to next level:  
- basic settings (MENU 1)  
- advanced settings (MENU 2)  
- diagnostics (MENU 3)

## CHANGING A ZIP CODE

See application note on ZIP CODE (76.0024).

- 1) Navigate to menu 3 (Diagnostics).      2) Select "ZIP code".      3) Change the code as desired.

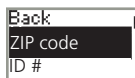

ZIP code  
E24 1 56-KG4  
01 0 800/02F

ZIP code  
E24 1 56-KG4  
01 0 800/02F

ZIP code  
E24 1 56-KG4  
01 0 800/02F

To activate the new ZIP code, you must validate the last digit (see below):

- v = valid ZIP code (values will be changed accordingly)
- x = invalid ZIP code (no values will be changed)
- v/x = valid ZIP code, but from a different product

... ZIP code  
H24 1 56-KG4  
01 0 800/02F

ZIP code  
v

\*only available values will be changed\*

ZIP code  
E24 1 56-KG4  
01 0 800/02F

## VALUE CHECK WITH REMOTE CONTROL



Pressing a parameter symbol on your remote control displays the saved value directly on the LCD screen. Additionally, the green LED will blink the number of times that the parameter is set to. Do not unlock first.

Note: When querying FIELD SHAPE, the green LED will blink the number of times that it is set to, and then the green LED will blink either 1 time (narrow shape) or 2 times (wide shape).

# 1 MOUNTING & WIRING

## MOUNTING

Using the provided mounting template, mount the sensor, ensuring that the bottom of the sensor is within 2 inches of the bottom of the door header.

Refer to Application Note 76.0035 if an IXIO Spacer is required for the given application.

Route the harness (20.5349) using the harness clip as shown in the exploded view of the mounting illustration.

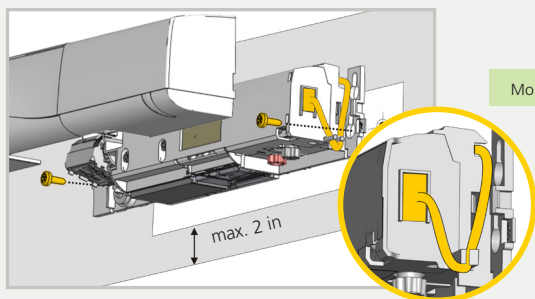

Mounting is compatible with the WIZARD.



Sensor connectivity (power and relays) must utilize only the supplied harness.

Sensor power and camera power must be supplied from a Class 2 supply source limited to 15 W.

Sensor is intended to be monitored for proper operation by the door operator or system.

Harness shall be routed separated from any Mains or non-Class 2 voltage cable for correct operation or shall be rated for the Mains voltage, and suitable protection and routing means shall be used according to National and Local Codes to prevent damage to the harness and/or IXIO sensor.

## WIRING

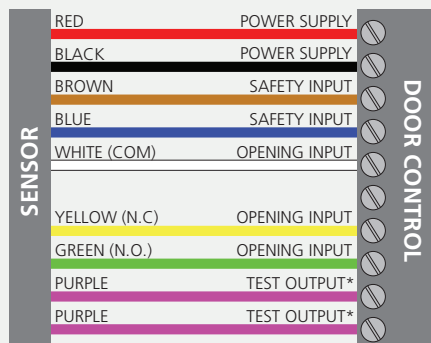

### VOLTAGE

Power: 12 – 24 VAC, 50/60 Hz  
12 – 30 VDC  
2.5 W (max)

Test: low: < 1 V  
high: > 10 V (30 V max.)  
response time: typ. < 5 ms

\* The sensor LED will briefly flash RED during monitoring communication with door control, indicating that external monitoring is functional. Monitoring functionality must be active on the sensor, door control, and monitoring wires must be properly connected to the door control.

## CAMERA HARNESS FOR DT1 V

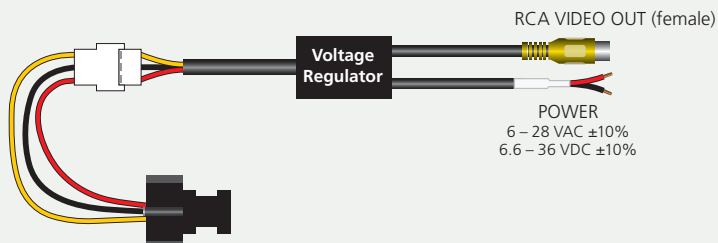

## 2 RADAR OPENING IMPULSE FIELD

The size of the detection field varies according to the mounting height of the sensor.

The following graphics are representations – not default settings.

### ANGLE

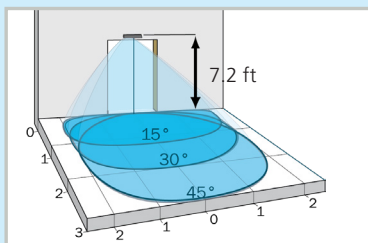

from 15° to 45°, default 30°

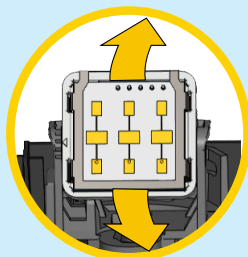

field size: 9  
immunity: 2

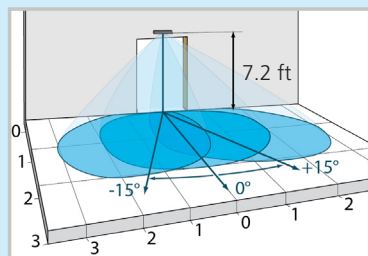

from -15° to +15°, default 0°

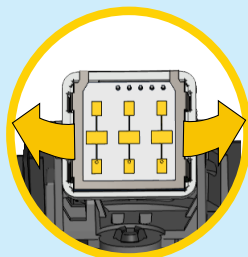

field size: 9  
immunity: 2

### WIDTH

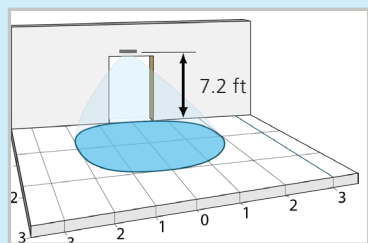

13' x 6'6" (wide)

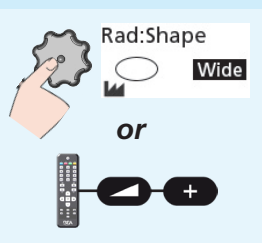

field size: 9  
immunity: 2

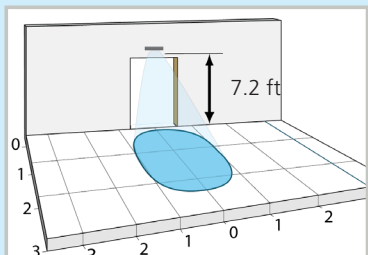

6'6" x 8' (narrow)

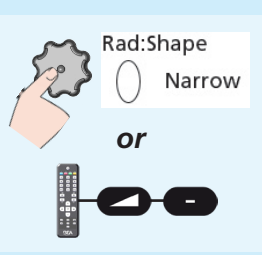

field size: 9  
immunity: 2

1 x 1 grid is approximately 3.28 ft x 3.28 ft.



### 3 INFRARED SAFETY FIELD

#### ANGLE

Activate the visible spots to verify the position of the AIR curtain.

Visibility depends on external conditions. When spots are not visible, use the Spotfinder to locate the curtains.

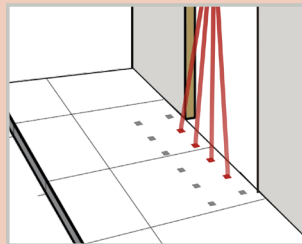

The distance between the inner curtain of the inside door sensor and the inner curtain of the outside door sensor should always be smaller than 8 in.

C1 = closest to sliding door

C2 = farthest from sliding door

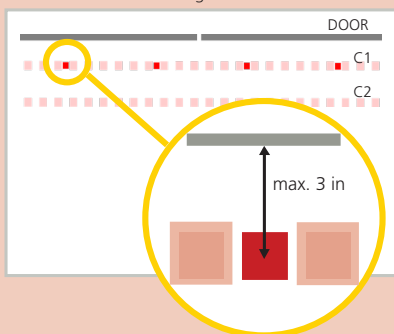

If necessary, adjust the AIR curtain angle (from -7° to 4°, default 0°).

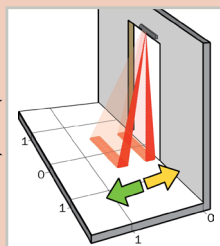

#### WIDTH

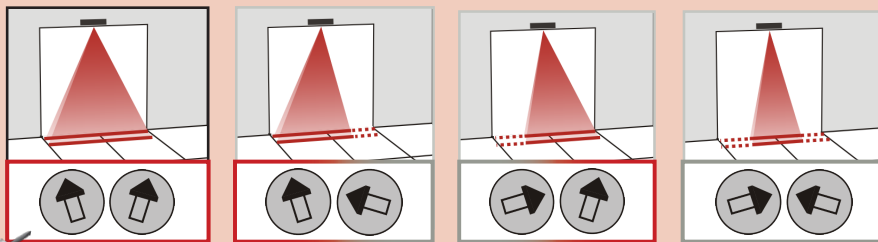

Part of the detection field can be masked to reduce its width. The arrow position determines the width of the detection field.

The size of the detection field varies according to the mounting height and the settings of the sensor.

Wide setting has 1:1 ratio. For example, a 6-foot mounting height will project a 6-foot detection width at floor.

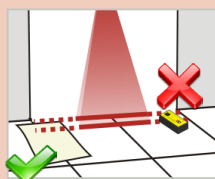

Always verify the actual detection field width by walk-testing according to ANSI 156.10.

Additional adjustments are possible by LCD or remote control (see OVERVIEW OF SETTINGS).



## 4 SETUP

Set up the sensor using either push-buttons or the remote control.



STEP OUT OF THE INFRARED FIELD!



### SETUP 1 (QUICK)

either hold the knob for 2 seconds, or use the remote control buttons as specified



+



### SETUP 2 (ASSISTED)

test of full door cycle + reference picture



+



TEST THE PROPER OPERATION OF THE INSTALLATION BEFORE LEAVING THE PREMISES!



LED flashes red-green



# OVERVIEW OF SETTINGS

## RC BUTTONS

	0	1	2	3	4	5	6	7	8	9	
<b>BASIC</b>	<div style="display: flex; justify-content: space-between;"> <span>Back More</span> <span>0 1 2 3 4 5 6 7 8 9</span> <span>RC Buttons</span> </div>										
RAD: FIELD SIZE	small	>	>	>	>	>	>	>	>	large	
RAD: SHAPE	LCD: "narrow" and "wide" setting options (default = wide) Remote Control: <b>+</b> = wide, <b>-</b> = narrow										
AIR: WIDTH											see note 1
AIR: OUTPUT		DeEner/NO NC	Energ/NC NO	Energ/NC NC	DeEner/NO NO						see note 2
TEST	off	on	on+auto								see note 3
<b>ADVANCED</b>	<div style="display: flex; justify-content: space-between;"> <span>Back More</span> <span>0 1 2 3 4 5 6 7 8 9</span> <span>RC Buttons</span> </div>										
RAD: FIELD SIZE	small	>	>	>	>	>	>	>	>	large	
RAD: IMMUNITY		low	>	>	>	>	>	>	>	high	
RAD: DIRECTION	off	bi	uni	MTF					uni + reentry		see note 4
RAD: HOLD TIME	auto	1 s	2 s	3 s	4 s	5 s	6 s	7 s	8 s	9 s	see note 5
RAD: REENTRY	small	>	>	>	>	>	>	>	>	large	
RAD: OUTPUT		DeEner/NO NC	Energ/NC NO	Energ/NC NC	DeEner/NO NO						see note 2
AIR: IMMUNITY		normal	enhanced					mode B			see note 1
AIR: WIDTH											see note 1
AIR: NUMBER		1	2								
AIR: PRESENCE TIME			30 s	1 min	2 min	5 min	10 min	20 min	60 min	infinte	
AIR: FREQ		A	B								
AIR: OUTPUT		DeEner/NO NC	Energ/NC NO	Energ/NC NC	DeEner/NO NO						see note 2
TEST	off	on	on+auto								see note 3
REDIRECTION	R1 MW R2 IR	R1 MV or R2 R									see note 6
FACTORY RESET									full reset	partial reset	see note 7

factory value

**DIAGNOSTICS**  
 ZIP CODE ID # all parameter settings in zipped format (see application note on ZIP CODE – 76.0024)  
 unique ID-number

CONFIG P/N  
 SOFT P/N  
 ERROR LOG last 10 errors + day indication  
 AIR: SPOTVIEW view of spot(s) that trigger detection  
 AIR: C1 ENERG signal amplitude received on curtain  
 AIR: C2 ENERG signal amplitude received on curtain 2  
 POWERSUPPLY supply voltage at power connector  
 OPERATINGTIME power duration since first startup

RESET LOG delete all saved errors  
 PASSWORD LCD and remote control password (0000= no password)  
 ADMIN enter code to access admin mode



motion (green)  
 presence (red)

**NOTES**





Note 1	Always use a screwdriver when making further AIR adjustments to the arrow position on the sensor.	
Note 2	<i><b>RADAR</b></i>	<i><b>AIR</b></i>
	NO = normally open NC = normally closed  DeEner = de-energized relay (active) Energ = energized relay (passive)	NO = normally open NC = normally closed
Note 3	The sensor LED will briefly flash RED during monitoring communication with door control. This indicates that external monitoring is functional.  Monitoring functionality must be active on the sensor and door control, and monitoring wires must be properly connected to the door control.	
Note 4	MTF = uni-directional with motion-tracking feature uni + reentry: BEA recommends only adjusting using the LCD	
Note 5	Auto mode evaluates traffic rate and adjusts hold time from 0.5 to 3 seconds	
Note 6	REDIRECTION setting (F1 on remote control):  <b>R1-MW, R2-IR (F1=0):</b> R1 = MW (i.e. motion detection) R2 = IR (i.e. presence detection)  <b>R1-MW or IR, R2-IR (F1=1):</b> R1 = MW or IR (i.e. motion or presence detection) R2 = IR (i.e. presence detection)	
Note 7	partial: outputs are not reset	

## LED SIGNALS









### COLORS

-  (green)  
Motion detection
-  (red)  
Presence detection







### BEHAVIORS

-  LED flashes
-  LED flashes quickly
-  LED flashes x times
-  LED flashes red-green
-  LED is off

## TROUBLESHOOTING

	E1: ORANGE LED flashes 1x	The sensor signals an internal fault.	Replace sensor.
	E2: ORANGE LED flashes 2x	The power supply voltage is too low/high.	Check power supply voltage in diagnostics menu (menu 3) of the LCD.
			Check wiring.
	E4: ORANGE LED flashes 4x	The sensor does not receive enough AIR energy.	Decrease the angle of the AIR curtains.
			Increase the AIR immunity filter.
			Deactivate curtain #2 (C2, outer curtain).
	E5: ORANGE LED flashes 5x	The sensor receives too much AIR energy.	Slightly increase the angle of the AIR curtains.
			Decrease the AIR immunity filter.
		The sensor is disturbed by external elements.	Eliminate the cause of disturbance (lamps, rain cover, door controller housing properly grounded).
	E8: ORANGE LED flashes 8x	AIR power emitter is faulty.	Replace sensor.
	ORANGE LED is on	The sensor encounters a memory problem.	Cut and restore power supply.
			If ORANGE LED illuminates again, replace the sensor.
	RED LED flashes quickly after an assisted setup	The sensor sees the door during assisted setup.	Move the AIR curtains away from the door.
			Install the sensor as close to the door as possible. If needed, use a bracket assembly.
			Ensure that the bottom of the sensor is mounted within 2" of the bottom of the door header.
			Launch a new assisted setup.
	RED LED illuminates sporadically	The sensor vibrates.	Check if the sensor is secure.
			Check position of cable and cover.
		The sensor sees the door.	Adjust the AIR angle and launch an assisted setup.
		The sensor is disturbed by external conditions.	Increase the AIR immunity filter.

## TROUBLESHOOTING (cont.)

	GREEN LED illuminates sporadically	The sensor is disturbed by rain and/or leaves.	Increase radar immunity filter.	
		Ghosting created by door movement.	Change radar field angle.	
		The sensor vibrates.	Check if the sensor and door cover is secure. Check position of cable and cover.	
		The sensor sees the door or other moving objects.	Remove the objects if possible. Change radar field size, angle, or immunity.	
	The LED and the LCD displays are off	No power to sensor.	Check wiring. Check for correct power supply.	
		The reaction of the door does not correspond with the LED signal	Check output configuration setting. Check wiring.	
	Cannot access LCD menu or change parameters via remote control	The sensor is protected by a password.	Enter the correct password. If you forgot the code, cut and restore the power supply to access the sensor without entering a password during 1 minute.	
		Sensor does not respond to remote control	Dead batteries.	Replace batteries.
			RED Visible External Monitoring (Test Indication LED) does not flash	Monitoring installation/setup error.
Sensor malfunction.	Replace the sensor.			
	RED Visible External Monitoring (Test Indication LED) flashes continuously	Wiring issue.	Verify wiring.	
		Door control not set correctly.	Verify door control monitoring set to Active Low.	
		Door cycles open and remains open	Door control monitoring set to Active High.	Set door control monitoring to Active Low.
Safety and/or Motion output is set incorrectly.			Correctly set the given output required for the door control.	

Can't find your answer?  
Visit [www.beainc.com](http://www.beainc.com) or scan QR code for Frequently Asked Questions!



Before contacting BEA Technical Support, locate the serial and CAN numbers of your sensor.

### SERIAL NUMBER

*view: back of sensor*

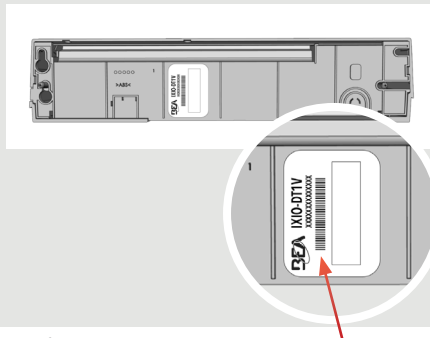

### CAN NUMBER

*view: top of sensor*

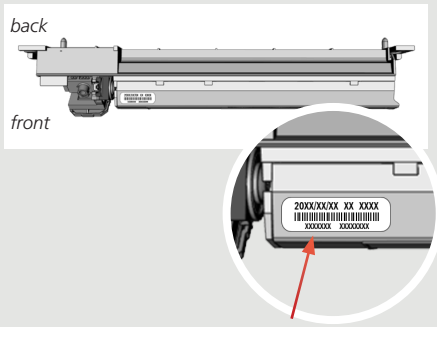





# ACCESSORIES AND REPLACEMENT PARTS

## ACCESSORIES

---



### 10IMB

Mounting bracket adapter



### 10CDA

Curved door accessory



### 10RETROFITSPACER

Retrofit Spacer Kit  
(includes spacer, 2.5" harness, and 9" harness)



### 10MINIBRACKET

Short, adjustable, mounting bracket



### 20.5302

Retrofit harness



### 10REMOTE

BEA universal remote control

## REPLACEMENT PARTS

---



### 10.1279

Replacement cover  
(includes camera)



### 20.5349

Replacement harness



### 20.2009

Replacement camera harness

