

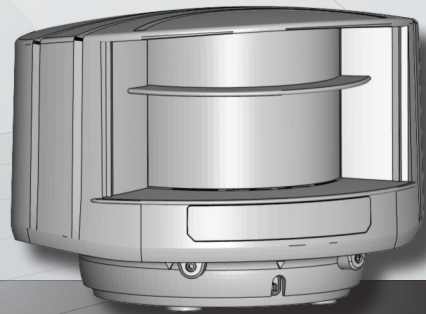

EN



LZR[®]-I30

LASER SCANNER FOR INDUSTRIAL DOORS
with max. detection range of 30 ft x 30 ft

User's Guide



Visit website for
available languages of
this document.



READ BEFORE BEGINNING INSTALLATION/PROGRAMMING/SET-UP

SAFETY

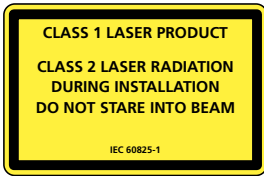

The device emits invisible (IR) and visible laser radiation.

IR laser: wavelength 905nm; output power 0.10mW
(Class 1 according to IEC 60825-1)

Visible laser: wavelength 635nm; output power 0.95mW
(Class 2 according to IEC 60825-1)

The visible laser beams are inactive during normal operation.
The installer can activate the visible lasers if needed.

Do not stare into visible laser beams.



CAUTION!

Use of controls, adjustments, or performance of procedures other than those specified herein may result in hazardous radiation exposure.

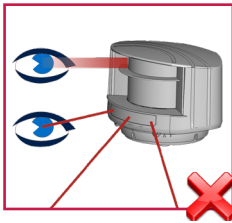

Do not look into the laser emitter or the visible red laser beams.

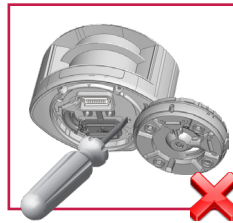

The warranty is void if unauthorized repairs are made or attempted by unauthorized personnel.



Only trained and qualified personnel are recommended to install and set up the sensor.



Test the proper operation of the installation before leaving the premises.

INSTALLATION AND MAINTENANCE



Avoid extreme vibrations.



Do not cover the laser windows.

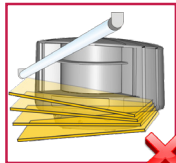

Avoid moving objects and light sources in front of the laser window.



Avoid the presence of smoke and fog in the detection field.



Avoid condensation on the laser windows.

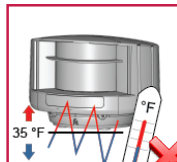

Avoid exposure to sudden and extreme temperature changes.

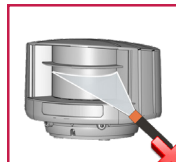

Avoid direct exposure to high pressure cleaning.



Do not use aggressive products to clean the laser windows.



Clean the laser window with compressed air. If needed, wipe only with a soft, clean and damp microfibre cloth.

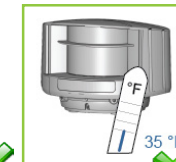

Keep the sensor permanently powered in environments where the temperature can drop below 35 °F.

READ BEFORE BEGINNING INSTALLATION/PROGRAMMING/SET-UP

DESCRIPTION

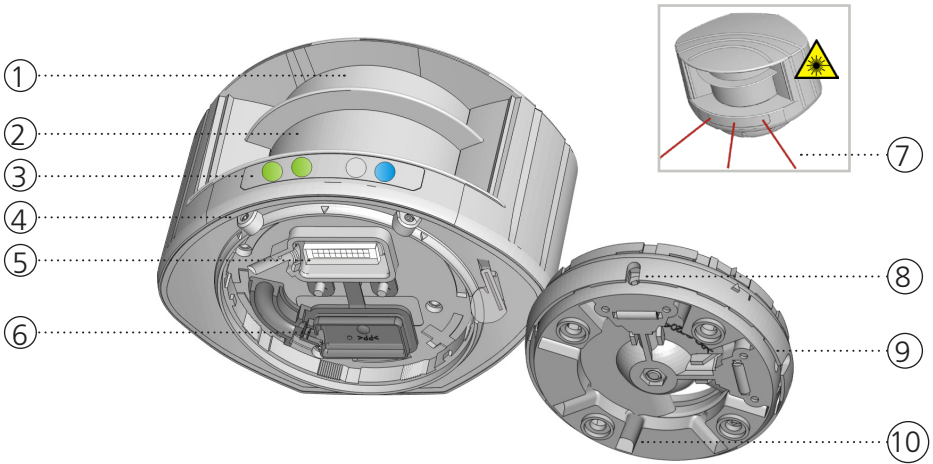

- | | |
|---------------------------------|--|
| 1. laser window – emission | 6. protection cover |
| 2. laser window – reception | 7. visible laser beams (3) |
| 3. LED signals (4) | 8. notches for tilt angle adjustment (2) |
| 4. screws for position lock (2) | 9. adjustable bracket |
| 5. connector | 10. cable conduits (4) |

LED SIGNAL

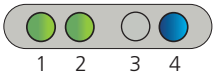

1. Detection LED: R1 – opening field
2. Detection LED: R2 – safety field
3. Error LED
4. Power LED



LED flashes quickly



LED flashes



LED flashes slowly



LED is off

DETECTION LEDs

detection (red)

no detection (green)

ERROR LED

error (orange)

no error (off)

POWER LED

power (blue)

no power (on)



All 4 LEDs can be switched off and on again by remote control. This can be useful in cases where the sensor should not draw any attention.

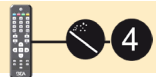

SYMBOLS



Caution!
Laser radiation



Remote control
sequence



Possible remote
control
adjustments



Factory values



Alarm



Tip



Quick
installation

READ BEFORE BEGINNING INSTALLATION/PROGRAMMING/SET-UP

HOW TO USE THE REMOTE CONTROL



After unlocking, the red LED flashes and the sensor can be adjusted by remote control.



If the red LED flashes quickly after unlocking, you need to enter an access code from 1 to 4 digits.



To end an adjustment session, always lock the sensor.

ADJUSTING ONE OR MORE PARAMETERS



CHECKING A VALUE

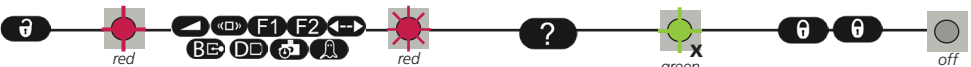

= field width: 4.2 m

= field width is defined by Learn

X = NUMBER OF FLASHES = VALUE OF THE PARAMETER

RESTORING TO FACTORY VALUES

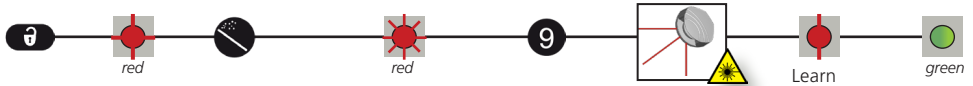

SAVING AN ACCESS CODE

The access code is recommended for sensors installed close to each other.



DELETING AN ACCESS CODE

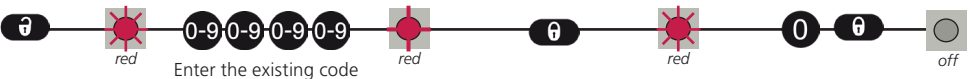

Enter the existing code



30 minutes after last use, the sensor locks access to the remote control session. To regain access, cycle the power. The remote control session will then be accessible for another 30 minutes.



1 MOUNTING

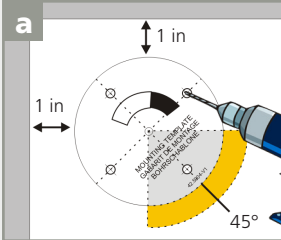
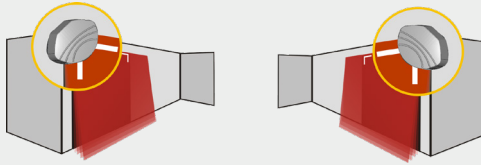

Use the mounting template to position the sensor correctly. The gray area indicates the detection range. Drill 4 holes as indicated on the template. Drill a hole (1/2 in min.) for the cable, if possible.

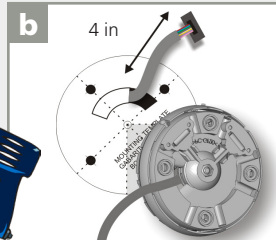

Pass the cable ± 4 in through the cable opening. If drilling an opening is not possible, use the cable conduits on the back side of the bracket.

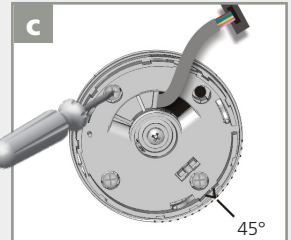

Position the bracket and secure using the 4 screws to avoid vibrations.

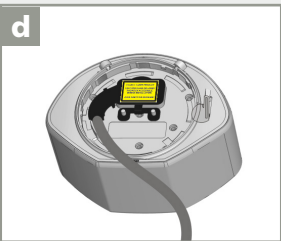

Open the protection cover, plug the connector, and position the cable in the slit. Close and secure the protection cover.

NOTE: FACTORY WARRANTY VOIDED IF PROTECTION COVER IS NOT USED!

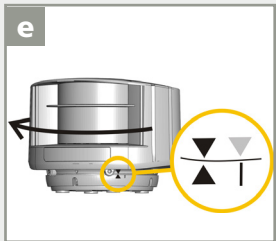



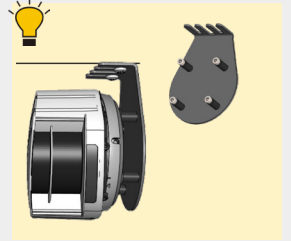







Position the housing on the bracket and rotate the sensor until the two triangles are face to face.



Use the LBA accessory if needed.

2 WIRING

Use the visual aid below to ensure correct wiring to the door control.

WIRE COLORS	FUNCTION
Red (+)  Black (-) 	Power supply (10 – 35 VDC)
White  Green 	Relay 1: Opening Field
White/Black  Green/White 	Relay 2: Safety Field
Blue (+)  Blue/White (-) 	Test
Orange  Orange/Black 	Learn

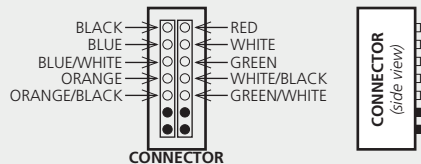

! No test function: connect blue and blue/white wires to power supply (no polarity)

3 POSITIONING



Unlock the sensor and activate the visible laser beams in order to position the curtains parallel to the door.

The visible laser beams stay activated for 15 minutes or can be turned off by the same sequence.

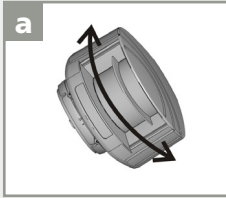

Adjust the **lateral position** of the detection field.

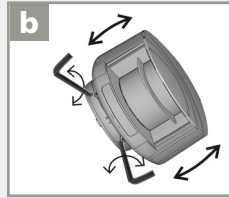

Adjust the **tilt angle** of the detection field with the hex key.

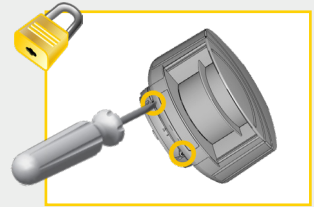

Lock the position of the mounting bracket to ensure consistent detection.

The distances between the curtains depend on the mounting height and location.

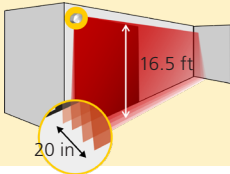

The visible laser beams indicate approximately the position of curtain C1.

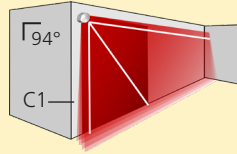

The distance between the inner curtains of the 2 sensors shall not exceed 8 in to ensure safety according to ISO 13849-1:2008 CAT 2, Pl «d».

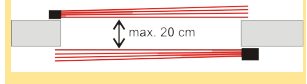

4 MOUNTING SIDE

Check and select the corresponding mounting side if necessary.

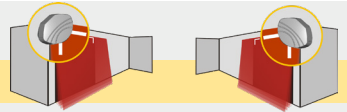

Stay outside of the detection field to avoid disturbances.

<<□>>

1

2

3

4

5

left

right

left

right

center

WITH BACKGROUND
The sensor memorizes the floor as reference point and signals a fault when its orientation is changed.

WITHOUT BACKGROUND
No reference point, no signal.

A learn is launched, the sensor learns its environment and automatically determines the detection field(s). Both red LEDs flash slowly and the 3 visible laser beams automatically illuminate during 30 seconds.



After setting the mounting side, the safety and the optional field have the same dimensions.

5 SAFETY FIELD CONFIGURATION (RELAY 2)

SAFETY FIELD LEARN

Launch a learn after changing the sensor position or when new objects are added/changed in the detection zone.

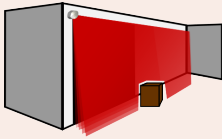
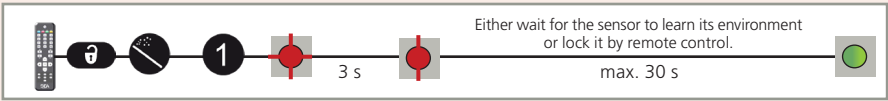

During learn, the sensor learns its surroundings and adapts the detection field shape to these. Objects in the detection field will be cut out.

FIELD DIMENSIONS

After the learn, the field dimensions can be changed by the remote control.

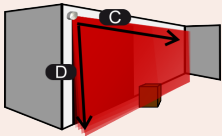
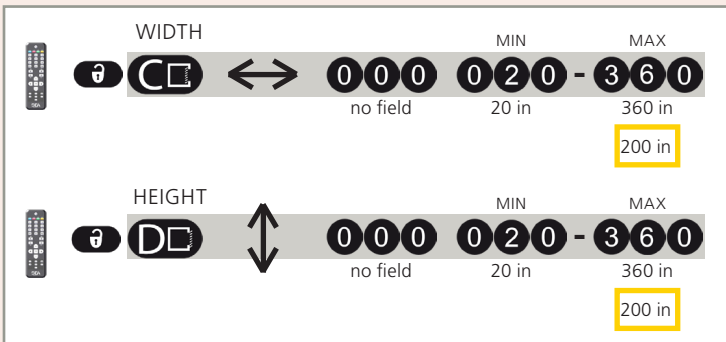

Ex: Lock icon 0 6 2 for a field width of 62 in



The default field dimension is limited to 200 in x 200 in. You can adapt the dimensions by remote control, but those dimensions cannot be larger than the shape defined by the learn.

6 OPTIONAL FIELD CONFIGURATION (RELAY 1)



Make sure the white and green wires are connected to the corresponding inputs before configuring the optional field.

VIRTUAL PUSH-BUTTON LEARN (VPB)

Install 1 or 2 virtual push-buttons as activation zone(s) to open the door «manually».

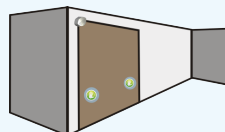
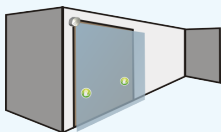

a Apply the virtual push button sticker(s) **within** the optional field.

b Launch a VPB learn to configure the detection zone(s).
When the red LED flashes very slowly after 3 seconds, hold your hand in front of the sticker to learn the detection zone. The green LED flashes 3x to confirm the selection.
When the red LED flashes again, learn a second (max. 2) detection zone or wait until the LED switches to green.

Launch a new VPB learn each time the sensor position is changed or new objects are added to or changed in the detection zone.

ATTENTION! This VPB learn is different from the safety field learn.

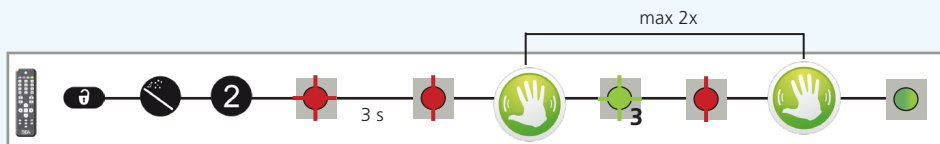

FIELD DIMENSIONS

Reduce the field dimensions if needed.



In order to configure the field dimensions, you have to cancel the virtual push-button function by launching a new VPB learn without any movement in the detection field.

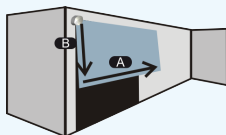
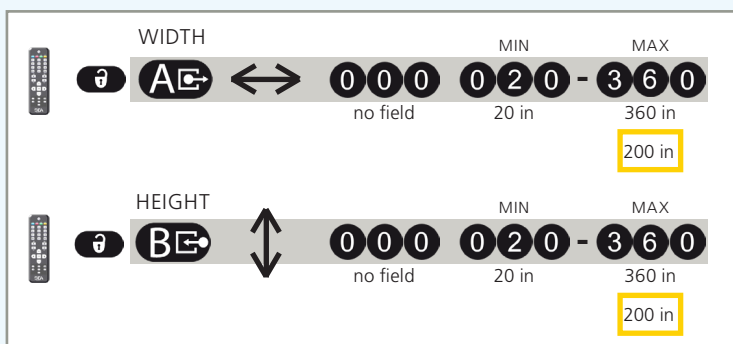

See page 9 to change output configuration to suitable applications.



IMPORTANT: Test the proper operation of the installation before leaving the premises.

REMOTE CONTROL ADJUSTMENTS (OPTIONAL)

ACTIVE DETECTION CURTAINS

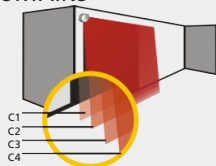

CURTAIN C1 C2 C3 C4

- 0 deactivate curtain on both fields
- 1 activate curtain only on optional field
- 2 activate curtain only on safety field
- 9 activate curtain on both fields

Ex:



C1 + C2 are active on safety field
C3 + C4 are active on optional field



C1 is active on both fields
C2+C3 are active on safety field
C4 is inactive



All curtains are active on both fields

The distances between the curtains depend on the mounting height and location. When mounted on the left, the distance between curtain C1 and curtain C4 is approximately 4 inches for every 3.25 feet (mounting height).

Example: At 200 inches, the distance between C1 and C4 is 20 inches.

UNCOVERED ZONE

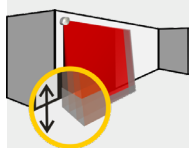

Increase in case of snow, dead leaves, etc.

F2	0	1	2	3	4	
	2	4	6	8	10	in

IMMUNITY FILTER

Choose between environment or object.

FOR CRITICAL ENVIRONMENTS
(e.g. RAIN, SNOW, FOG)

FOR CRITICAL OBJECTS
(e.g. BLACK CARS)

indoor	outdoor low	outdoor med	outdoor high	indoor	outdoor low	outdoor med	outdoor high
1	2	3	4	5	6	7	8

MIN. OBJECT SIZE

(approximate values)

0	1	2	3	4
off	2	4	6	8

OUTPUT ACTIVATION DELAY

(approximate values)

The outputs are triggered after a constant detection time of x ms. (ex: value 3 = 300 ms)

0	1	2	3	4	5	6	7	8	9
off	100	200	300	400	500	600	700	800	900

DETECTION FIELD REDIRECTION

R = relay output

F1	0	1
R1	optional	optional or safety
R2	safety	safety

OUTPUT CONFIGURATION

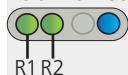

R = relay output

	1	2	3	4
R1 Optional field	A - NO	P - NC	P - NC	A - NO
R2 Safety field	P - NC	A - NO	P - NC	A - NO

A = active
P = passive

NO = normally open
NC = normally closed

TROUBLESHOOTING

	No blue LED	No power	Check cable and connexion.
		Polarity of power supply is inverted	Check the polarity of the power supply.
		All LEDs have been deactivated by remote control	Activate LEDs using remote control.
	Only blue LED is on	Test input is not connected	Check wiring. The blue and blue/white cable must be connected to the test input or the power supply.
	Detection LED remains green	Detection field too small or deactivated	Check size of fields.
		Object size is too small	Launch a learn.
		Someone/Something is in the detection field	Decrease minimum object size.
	Detection LED remains red	Field is touching floor/wall/door/object/person – this leads to detection	Step out of the field and/or remove the any object(s) from the field.
		No background (reference point) is found	Activate the 3 red beams and check if the position of the sensor is correct. If not, adjust the hex screws.
	Orange LED flashing and detection LEDs are red	Sensor is masked	Verify the field size.
		Power supply voltage exceeds acceptable limits	Launch a learn.
	Orange LED is on	Sensor exceeds temperature limits	Check position of sensor.
		Internal error	Check the mounting side setting. If no reference point is found, set the mounting side to value 3 to 5.
		30 minutes after last use, sensor locks access to RC	Launch a new learn.
	Sensor does not respond to the remote control	Remote control batteries not installed properly or are dead	Verify and clean the front screens with a damp cloth.
		Remote control not pointed correctly	Check power supply voltage.
		Reflective object is close to the sensor	Verify the temperature of the environment. Protect the sensor from sunlight using a cover, if necessary.
	Sensor does not unlock	Access code needs entered or an incorrect code was used	Wait a few seconds. If the LED remains ON, reset the power supply. If the LED turns on again, replace the sensor.
			Cut and restore power supply. RC is accessible again for 30 minutes.
			Check battery orientation or replace the batteries.
			Point the remote control towards the sensor, but with a slight angle. The RC should not be pointed in a right angle in front of the sensor.
			Avoid highly reflective material in proximity to the sensor.
			Cut and restore power supply. No code is required to unlock during the first minute after powering.



Can't find your answer?
Visit www.beainc.com or scan QR code for Frequently Asked Questions!

TECHNICAL SPECIFICATIONS

Technology:	laser scanner, time-of-flight measurement		
Detection mode:	motion and presence		
Max. detection range:	30' x 30'		
Uncovered zone:	2 – 19" (adjustable)		
Remission factor:	> 2%		
Angular resolution:	0,3516°		
Min. detected object size (typ.): (in proportion to obj. distance)	0.8 in @ 118 in 1.4 in @ 197 in 2.75 in @ 30 ft		
Testbody:	700 mm x 300 mm x 200 mm (testbody A according to EN 12445)		
Emission characteristics IR laser: Red visible laser:	wavelength 905 nm; output power 0.10mW (CLASS 1) wavelength 635 nm; output power 0.95mW (CLASS 2)		
Supply voltage:	10 – 35 VDC @ sensor side (to be operated from SELV-compatible power supplies only)		
Power consumption:	< 5 W		
Peak current @ power-on:	1.8 A (max. 80 ms @ 35 V)		
Cable length:	33'		
Response time:	typ. 20 ms (max. 80 ms) + output activation delay		
Output: Max. switching voltage: Max. switching current: Switching time: Output resistance: Voltage drop on output: Leakage current:	2 electronic relays (galvanic-isolated – polarity-free) 35 VDC / 24 VAC 80 mA (resistive) $t_{ON} = 5$ ms; $t_{OFF} = 5$ ms typ 30 Ω < 0.7 V @ 20 mA < 10 μ A		
Input: Max. contact voltage: Voltage threshold:	2 optocouplers (galvanic-isolated – polarity-free) 35 VDC (over-voltage protected) Log. H: > 8 VDC Log. L: < 3 VDC		
Response time monitoring input:	< 5 ms		
LED signal:	1 blue LED: power-on status 1 orange LED: error status 2 bi-colored LEDs: detection/output status (green = no detection, red = detection)		
Dimensions (D x W x H):	5.0" x 3.6" x 2.75" (mounting bracket + 0.55 in)		
Material:	PC/ASA		
Color:	Black		
Mounting angles on bracket:	-45°, 0°, 45°		
Rotation angles on bracket:	-5 – 5 ° (lockable)		
Tilt angles on bracket:	-3 – 3 °		
Protection degree:	IP65 / NEMA 4		
Temperature range:	-22 – 140 °F if powered		-14 – 140 °F if unpowered
Humidity:	0 – 95% non-condensing		
Vibrations:	< 2G		
Pollution on front screen:	max. 30%, homogenous		
Norm conformity:	2006/95/EC: LVD 2004/108/EC: EMC IEC 60825-1:2007 IEC 61000-6-2:2005 2002/95/EC: RoHS EN 60529:2001 IEC 60950-1:2005 IEC 61000-6-3:2006 2006/42/EC: MD EN 12978:2009 IEC 61496-1:2009 IEC 62061:2005 SIL 2 EN 12453:2000 chapter 5.1.1.6, chapter 5.5.1 Safety device E EN ISO 13849-1:2008 CAT2, Pl «d» EN 61496-3:2008 ESPE Type 2		

Specifications are subject to change without prior notice.

All values measured in specific conditions.

BEA, INC. INSTALLATION/SERVICE COMPLIANCE EXPECTATIONS

BEA, Inc., the sensor manufacturer, cannot be held responsible for incorrect installations or incorrect adjustments of the sensor/device; therefore, BEA, Inc. does not guarantee any use of the sensor/device outside of its intended purpose.

BEA, Inc. strongly recommends that installation and service technicians be AAADM-certified for pedestrian doors, IDA-certified for doors/gates, and factory-trained for the type of door/gate system.

Installers and service personnel are responsible for executing a risk assessment following each installation/service performed, ensuring that the sensor/device system performance is compliant with local, national, and international regulations, codes, and standards.

Once installation or service work is complete, a safety inspection of the door/gate shall be performed per the door/gate manufacturer's recommendations and/or per AAADM/ANSI/DASMA guidelines (where applicable) for best industry practices. Safety inspections must be performed during each service call – examples of these safety inspections can be found on an AAADM safety information label (e.g. ANSI/DASMA 102, ANSI/DASMA 107, UL294, UL325, and International Building Code).

Verify that all appropriate industry signage, warning labels, and placards are in place.

