

LZR[®]-WIDESCAN

OPENING, PRESENCE, & SAFETY SENSOR FOR INDUSTRIAL DOORS



A Halma company

EN



Visit website for available languages of this document.



Download the installation app!

PROGRAMMING

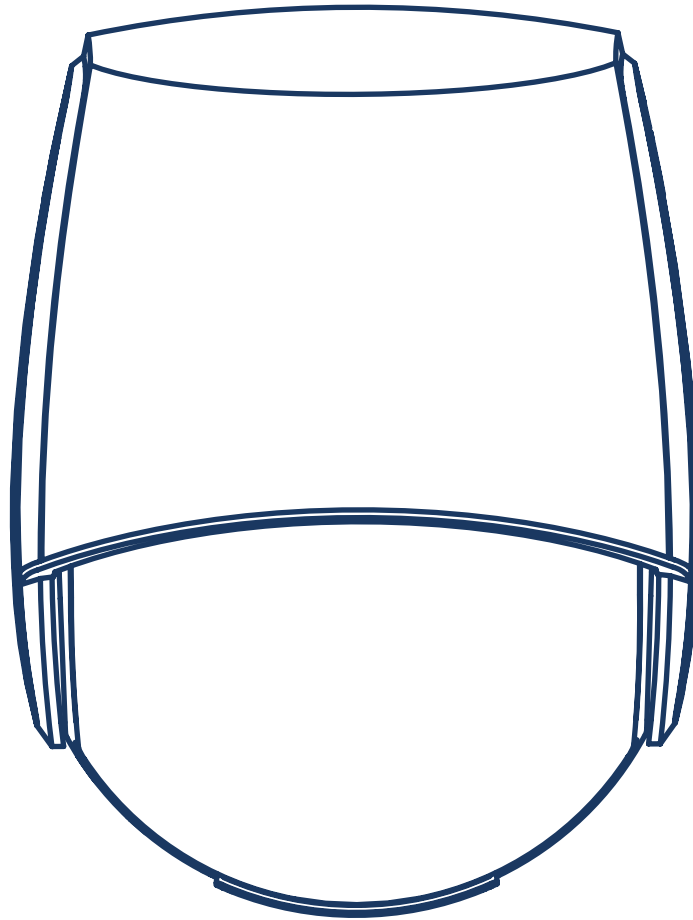

TECHNICAL SPECIFICATIONS

TECHNOLOGY / PERFORMANCE

Technology	LASER scanner, time-of-flight measurement (7 laser curtains)
Detection mode	motion, presence, height, and speed
Max. detection field	width: 1.2 × mounting height depth: 1.2 × mounting height adjustable, depending on user settings
Thickness of first curtain	¼"
Typ. mounting height	6'6" – 32'
Min. reflectivity factor	> 2 % (of floor and object) (measured at max. 19'6" in safety field)
Typ. min. object size	6" at 19'6" (in proportion to object distance)
Testbody	27 ½" × 11 ¾" × 7 ¾"

ELECTRICAL

Emission characteristics

IR laser:	wavelength 905 nm; output power 0.10mW (CLASS 1)
Red visible laser:	wavelength 635 nm; output power 0.95mW (CLASS 2)

Supply voltage	12 – 24 VAC -10/+20% 12 – 30 VDC ±10% at sensor terminal
-----------------------	---

Power consumption	< 2.5 W (heating = OFF) < 10 W, max 15 W (heating = ECO or AUTO)
--------------------------	---

Response time	typ. 230 ms max. 800 ms (depending on immunity settings)
----------------------	---

Output	2 solid-state relays (galvanic isolation, polarity free) 24 VAC / 30 VDC (max. switching voltage) 100 mA (max. switching current) - in switching mode: NO/NC - in frequency mode: pulsed signal (f= 100 Hz ±10%) 1 electro-mechanic relay (galvanic isolation, polarity free) 42 VAC/VDC (max. switching voltage) 500 mA (max. switching current)
---------------	--

Input	30 VDC (max. switching voltage) low < 1 V high > 10 V (voltage threshold)
--------------	---

Bluetooth communication	operating bandwidth: 2402 - 2480 MHz max. transmitted power: 12 dBm
--------------------------------	--

PHYSICAL

Dimensions	7 ¾" (H) x 6" (W) x 4" (D) (approx.)
-------------------	--------------------------------------

Material / Color	PC, ASA / Black
-------------------------	-----------------

Protection degree	NEMA 4 / IP65
--------------------------	---------------

Temperature range	-22 – 140 °F
--------------------------	--------------

Rotation angles on bracket	45° to the right 15° to the left (both directions lockable)
-----------------------------------	---

Tilt angles on bracket	-10 – 5°
-------------------------------	----------

LED signals	2 tri-colored LED: output status / remote control response / error signals 1 blue LED: Bluetooth status
--------------------	--

COMPLIANCE

Compliance	EN 300 328 V2.2.2, EN 301 489-1 V2.2.2, EN 301 489-17 V3.2.0, EN 60825-1:2014, EN 62311:2008
-------------------	--

Specifications are subject to change without prior notice.
All values measured in specific conditions.

SAFETY

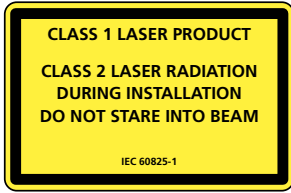

The device emits invisible (IR) and visible laser radiations that can be activated during the installation process to adjust precisely the position of the detection field.

The visible laser beams are inactive during normal functioning.

Do not stare into visible laser beams.

CAUTION! Use of controls, adjustments, or performance of procedures other than those specified herein may result in hazardous radiation exposure.

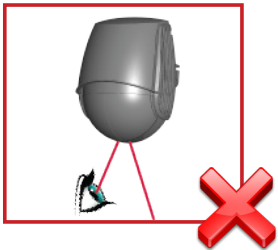

Do not look directly into the laser emitter or the visible red laser beams.

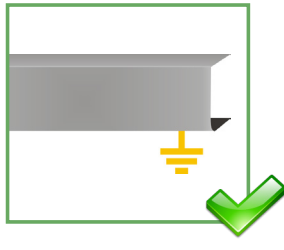

The door control unit and the header cover profile must be correctly grounded.



Only trained and qualified personnel are recommended to install and set up the sensor.

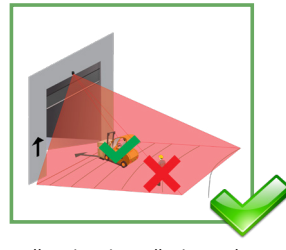

Following installation, always test for proper operation before leaving the premises.

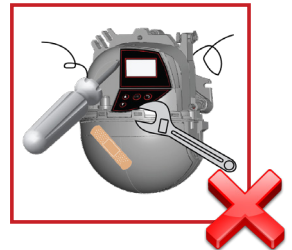

The warranty is invalid if unauthorized repairs are made or attempted by unauthorized personnel.

LED SIGNALS & SYMBOLS

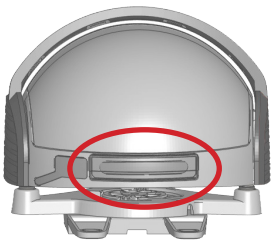

LED on



LED off



LED flashing



LED flashing quickly



LED flashing slowly



LED flashing x times

GENERAL



Unlocked



Teach-in status



Troubleshooting

DETECTION



Motion detection



Pull-cord detection



Presence detection



Safety detection

SMARTPHONE



Not connected



Connected

FIELD-SPECIFIC PROGRAMMING



All fields



Motion field



Pull-cord



Presence field



Safety field



Setting any field width or depth to 000 will eliminate that field along with its associated LED flash.

WHAT'S IN THE BOX

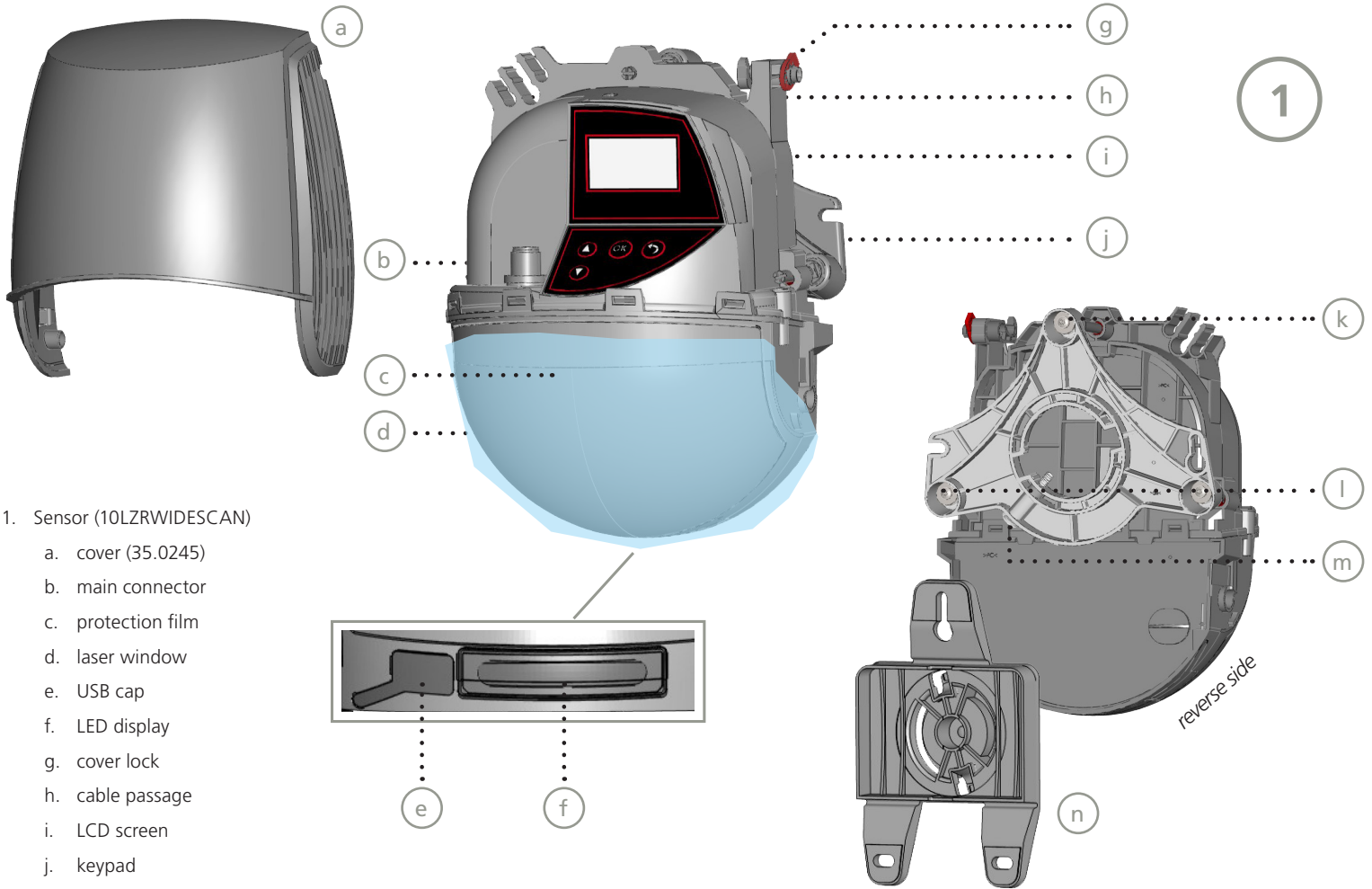

1. Sensor (10LZRWIDESCAN)
 - a. cover (35.0245)
 - b. main connector
 - c. protection film
 - d. laser window
 - e. USB cap
 - f. LED display
 - g. cover lock
 - h. cable passage
 - i. LCD screen
 - j. keypad
 - k. tilt angle adjustment screw (1)
 - l. parallel angle adjustment screw (2)
 - m. lateral angle lock screw (1)
 - n. mounting bracket (41.8838)

2. Power cable (35.1554)
3. Mounting screws (50.0048)
4. Mechanical Installation Guide (75.0047)
5. Programming Guide (75.0048)
6. LZR-WIDESCAN Menu Tree (78.8004)

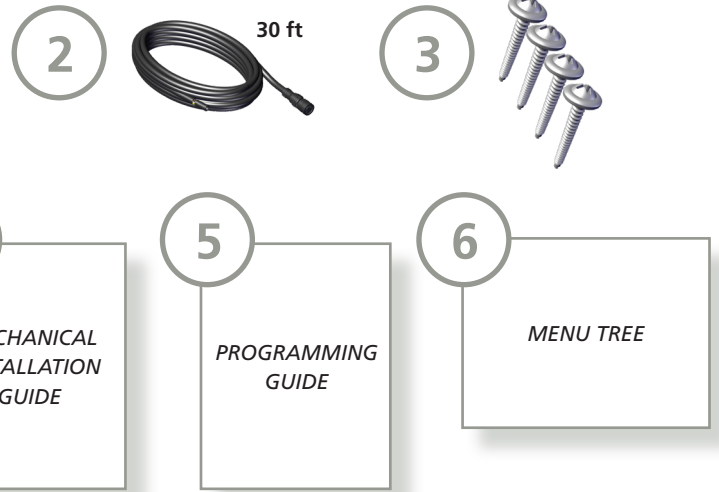

WHAT YOU'LL NEED



Phillips head screwdriver



LZR-WIDESCAN mobile app
(not required, but highly recommended)





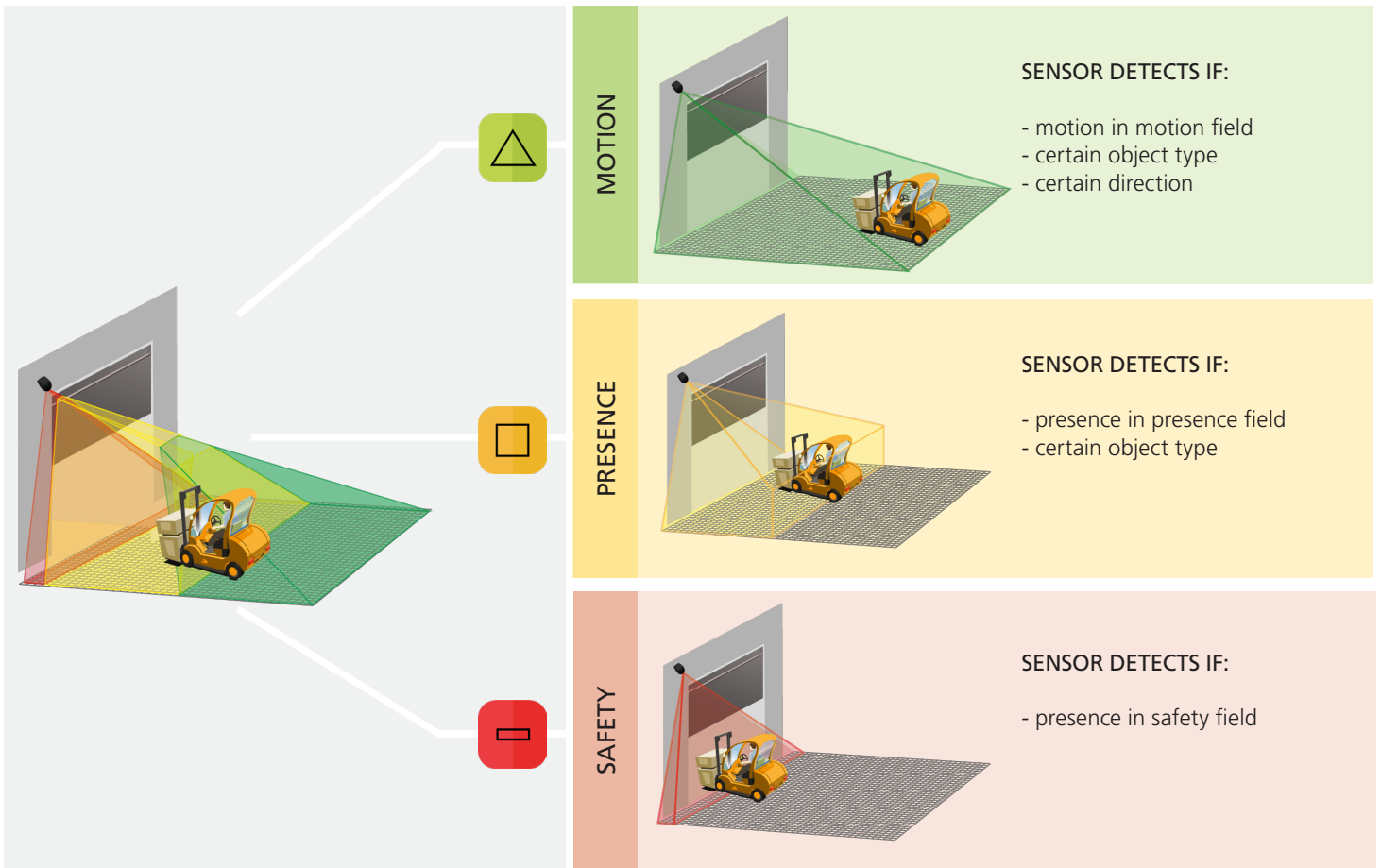

BEA Remote Control

BASIC PRINCIPLES

There are 3 main functions that create **3 overlapping detection fields**, each with certain detection characteristics:



There are 4 additional opening functions. All detection functions can be combined to trigger a specific output.

-  **Motion +:** detection of other moving object type in motion field
-  **Pull-cord:** detection of object in learned, pull-cord zone
-  **Speed:** detection of object with a minimum speed
-  **Height:** detection of object with a minimum height

The sensor carries out a 3D object analysis and detects depending on height, width, depth, direction, and speed.

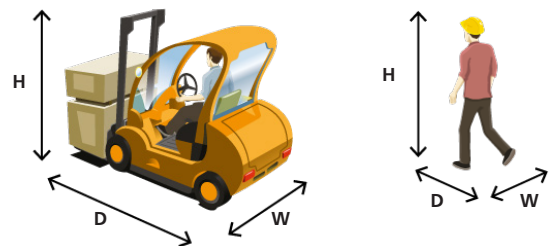

PROGRAMMING

BEA offers 3 ways to set up and program the LZR-WIDESCAN: LCD, remote control, and mobile app. Each step in the programming instructions will illustrate all 3 options.



BEA highly recommends downloading the LZR-WIDESCAN mobile app.

The mobile app is an incredibly useful tool for mechanical installation verification and setup/programming.

See *LZR-WIDESCAN Mobile App Registration (75.0029)* for information regarding app registration and Bluetooth-pairing sensors.



BEFORE GETTING STARTED

Before beginning any programming, be sure to complete the following pre-check. Not doing so could result in teach-in errors that will delay the programming process.

Make sure the blue protection film and cover are removed!

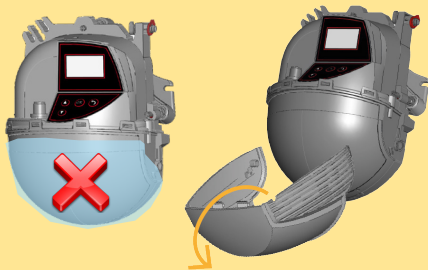

Check your profile setting before beginning installation.



"First Installation" profile has a simplified list of settings.

"Fine tuning" profile has the full list of settings. This should be used for installations requiring more customization.

The teach-in zone (i.e. square in front of the 2 visible spots) must be completely clear.

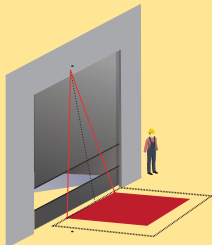

A teach-in must be launched each time a sensor angle has been changed.

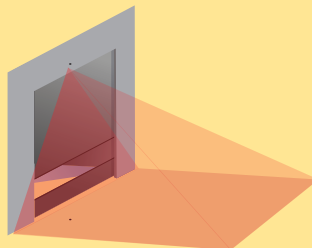

Use the VIEWER feature of the mobile app to verify the field size each time a field is modified.

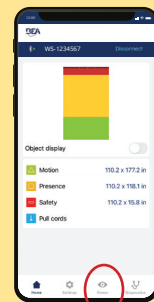

1 TEACH-IN: INSTALL

VIA MOBILE APP (preferred)

1. Verify settings from the physical installation, and then follow the prompt for the teach-in process to begin.
2. Clear the area and press "Start teach-in process" at the bottom of the screen.
3. The app will notify when the teach-in is complete. Press "OK" to move forward to Outputs.

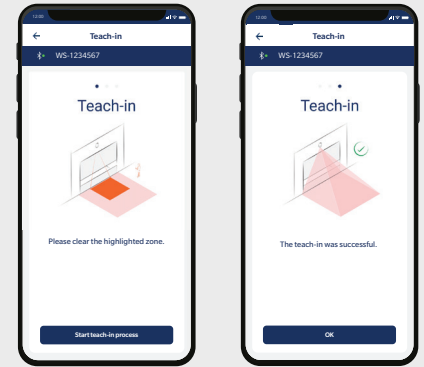

VIA REMOTE CONTROL

1. Launch a teach-in by remote control. The teach-in process will start after 5 seconds.
2. Wait while the position, angle, and height are learned and the background is analyzed.
3. The teach-in will end automatically.

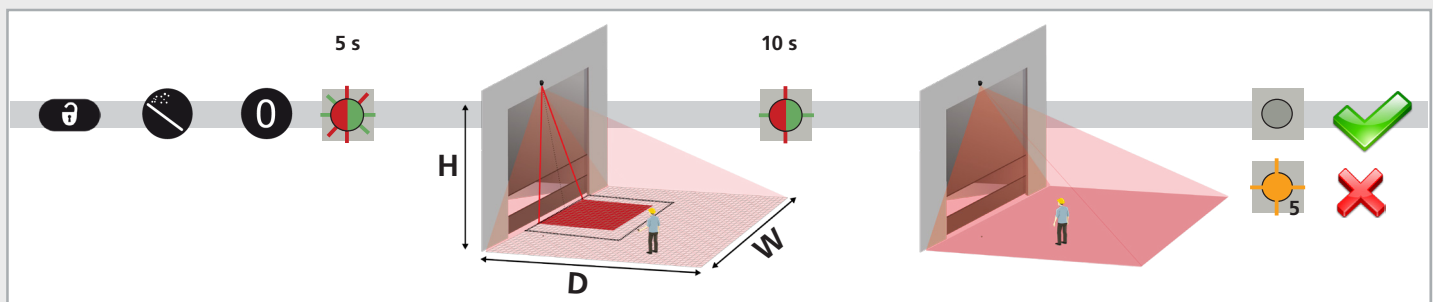

Instructions for a walk teach-in may be found in the Appendix, pages 29 – 30.

VIA LCD (not preferred)

To change a setting, see page 27 for **How To Use the LCD**, and use the following menu paths.

Main menu

Quick Start

Teach In

Install*	basic teach-in
Install Left*	to be used when permanent objects are in the default learn area learns the area to the left of the left red spot; same size as Install teach-in area
Install Right*	to be used when permanent objects are in the default learn area learns the area to the right of the right red spot; same size as Install teach-in area
Pull Cord	can only set Pull Cord #1; allows 60 seconds to reach desired pull cord learn area
Walk Safety	learns and sets the Safety field; see Appendix for more information
Walk Presence	learns and sets the Presence field; see Appendix for more information
Walk Motion	learns and sets the Motion field; see Appendix for more information
Walk All	learns and sets all fields; see Appendix for more information
Background	evaluates the background area of the overall field; does not calculate tilt, azimuth, and height

* teach-in option only samples a portion of the overall field to assess; does not set field size/shape

2 ASSIGN OUTPUT FUNCTIONS, OUTPUT LOGIC, AND HOLD TIMES

VIA MOBILE APP (preferred)

1. Once the teach-in is complete, review the three Outputs settings and make adjustments as necessary.

To make an adjustment, simply click on the edit icon beside the current setting.

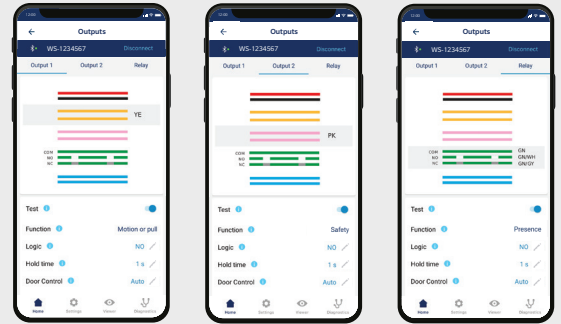

2. You can also set Pull Cords (3 max.)

To set a Pull Cord, simply swipe left on the "Create pull cord" option and click "Install."

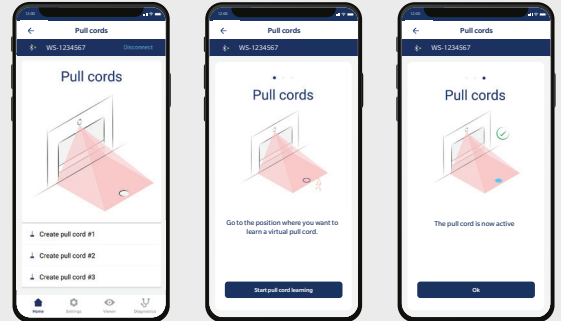

VIA REMOTE CONTROL

To change an Output setting, the remote control key sequence is as follows:

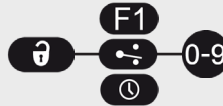

When programming each of the parameters listed below you must always enter 3 digits for the given parameter. Be sure to enter all digits quickly to avoid a time-out.

If you do not want to change the setting of an output, select 0.

- 1st digit = Output 1
- 2nd digit = Output 2
- 3rd digit = Relay

EXAMPLE: If your desired outputs are Motion or Pull-Cord (Output 1), Pull-Cord (Output 2), and Safety (relay), you must use the following remote control key sequence:

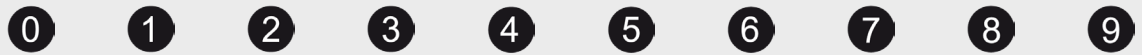

		0	1	2	3	4	5	6	7	8	9
F1 Out1 Funct.	no change	no change	motion or pull-cord	presence or safety	presence	safety	pull-cord	motion + speed	motion + height	motion pull-cord safety	motion pull-cord presence
F1 Out2 Funct.	no change	no change	motion or pull-cord	presence or safety	presence	safety	pull-cord	presence + height	motion + height	motion pull-cord safety	motion pull-cord presence
F1 Relay Funct.	no change	no change	motion or pull-cord	motion	presence	safety	pull-cord	motion + speed	motion + height	motion pull-cord safety	motion pull-cord presence
Out1 Logic*					N.O.	N.C.	* output status during non-detection ** passive = de-energized when in detection or loss of power ***active: energized when in detection or loss of power				
Out2 Logic*					N.O.	N.C.					
Relay Logic*			passive**	active***							
Out1 Holdtime	100 ms	100 ms	1 s	3 s	5 s	10 s	30 s	1 min	5 min	10 min	counting [†]
Out2 Holdtime	100 ms	100 ms	1 s	3 s	5 s	10 s	30 s	1 min	5 min	10 min	counting [†]
Relay Holdtime	100 ms	100 ms	1 s	3 s	5 s	10 s	30 s	1 min	5 min	10 min	counting [†]

[†] 400 ms (for vehicle counting)

2 ASSIGN OUTPUT FUNCTIONS, OUTPUT LOGIC, AND HOLD TIMES (cont.)

VIA LCD (not preferred)

To change a setting, see page 27 for **How To Use the LCD**, and use the following menu paths.

Main menu

In-Out

Out1 Funct: Mot Pull Pres / Mot Pull Safe / Mot+ & Height / Mot+ & Speed / Pull Cord / Safety / Presence / Mot Pull / Motion / Not Used

Out2 Funct: Mot Pull Pres / Mot Pull Safe / Mot+ & Height / Pres & Height / Pull Cord / Safety / Presence / Mot Pull / Motion / Not Used

Relay Funct: Mot Pull Pres / Mot Pull Safe / Mot+ & Height / Mot+ & Speed / Pull Cord / Safety / Presence / Mot Pull / Motion / Not Used

> More

Out1 Logic: NC / NO

Out1 Holdtime: counting[†] / 10 min / 5 min / 1 min / 30 s / 10 s / 5 s / 3 s / 1 s / 100 ms

Out1 Test: On / Off

Out2 Logic: NC / NO

Out2 Holdtime: counting[†] / 10 min / 5 min / 1 min / 30 s / 10 s / 5 s / 3 s / 1 s / 100 ms

Out2 Test: On / Off

Relay Logic: Active NO NC / Passive NC NO

Relay Holdtime: counting[†] / 10 min / 5 min / 1 min / 30 s / 10 s / 5 s / 3 s / 1 s / 100 ms

Relay Test: On / Off

[†] 400 ms (for vehicle counting)

3 PROGRAM FIELD SETTINGS

The WIDESCAN has three outputs that can be configured to motion, presence, and/or safety functions depending on your application.

See below for an explanation of each field and how they work, and associated LED colors.

See pages 11 – 18 for how to make adjustments to each field using the mobile app, remote control, and LCD menu.

MOTION

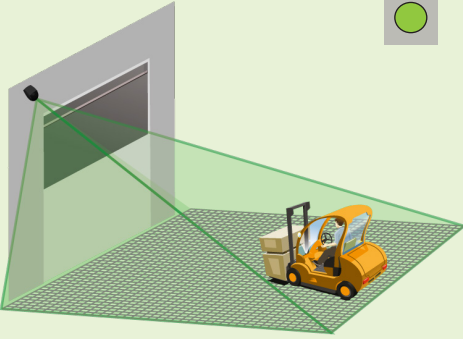

The motion field detects objects moving through the programmed field.

- The max width, depth, start are adjustable nearly to the inch.
- You can select settings to only identify objects moving in certain directional patterns (see Direction setting).
- You can also choose an Object Type to reject pedestrians and only detect vehicles.

This field is defaulted to relay 3.

When setting parameters for this field, the LED illuminates solid green.

PULL CORDS

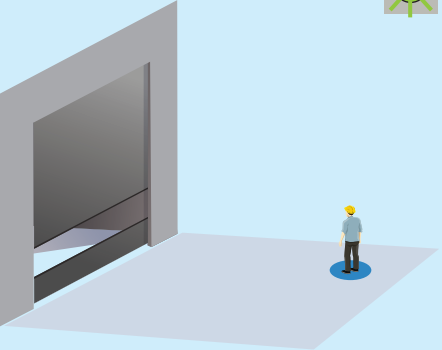

A virtual pull cord is a smaller detection zone that triggers the door to open when an object is present within it during a desired amount of time (minimum presence time).

- You can program up to three virtual pull cords.
- In order to use this function:
 - the sensor must know its environment: teach-in install is OK
 - the corresponding wires must be connected to the door activation input (relay output by default)
 - the output or relay function must be set to "motion or pull cord" (factory value) or "pull cord"

When this field is in detection or when setting parameters for this field, the LED quickly flashes green.

PRESENCE

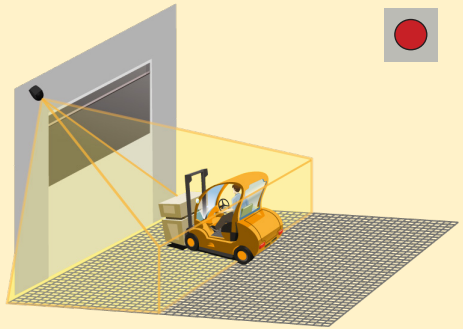

The presence field detects objects (moving or stationary) through the programmed field.

- The max width, depth, start are adjustable nearly to the inch.
- You can also choose an Object Type to reject pedestrians and only detect vehicles.
- The maximum presence time feature allows the sensor to be more adaptable to the environment.

This field is defaulted to relay 2.

When setting parameters for this field, the LED illuminates solid red.

SAFETY

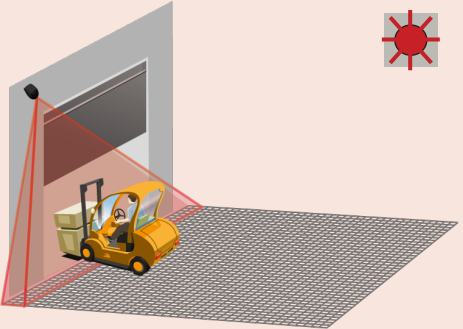

The safety field detects objects (moving or stationary) through the programmed field.

- The max width and depth are adjustable nearly to the inch.
- The maximum presence time feature allows the sensor to be more adaptable to the environment and incorporates a height filter (less than 18").
- The uncovered zone feature helps the sensor to not detect smaller objects that are close to the ground.

This field is defaulted to relay 1.

When setting parameters for this field, the LED quickly flashes red.

SETTINGS EXPLAINED

FIELD WIDTH

When facing the door, this is the measurement that extends from the center to the left and right sides equally.

FIELD STOP

When facing the door, this is the measurement (also considered depth) that extends straight out from the door.

FIELD START

When facing the door, this is the distance from the threshold that the field coverage begins (i.e. the closest part of the field to the door).

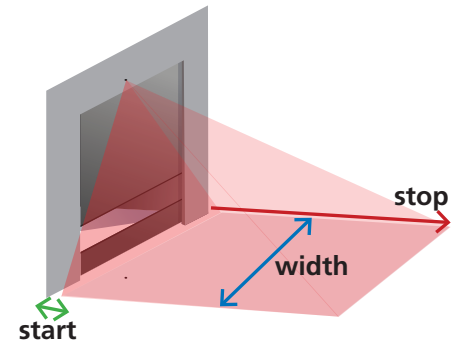

For all three of the above parameters, the maximum reachable dimensions will automatically adapt according to mounting height.

To eliminate a field, set the width or stop field to 000.

OBJECT TYPE

This setting offers a filtering aspect to reject detection of certain objects based on their perceived width.

Vehicle XL: the sensor will only detect large objects and rejects smaller vehicles such as bicycles and narrow forklifts.

Vehicle: the sensor will detect all vehicles no matter their size, but rejects pedestrians.

Any: the sensor detects all objects regardless of size (with respect to the typical minimum object size – see Technical Specifications, page 2).

DIRECTION

This setting offers a filtering aspect to reject objects that are not moving in a desired direction.

<p>ANY</p> <p>bidirectional detection – approaching and going away</p>	<p>UNI 100% (default)</p> <p>unidirectional detection – approaching with cross traffic rejection</p>	<p>UNI REV</p> <p>unidirectional detection with inversion – only going away</p>
<p>UNI 100%+</p> <p>unidirectional detection – approaching with cross traffic rejection +1m in front of door : bidirectional detection without cross traffic rejection</p>	<p>UNI</p> <p>unidirectional detection – approaching in any direction (distance between object and sensor decreases)</p>	

IMMUNITY

This setting allows for increasing or reducing the sensitivity of the field for detecting an object.

Setting 1 is the most sensitive and will detect quickly.

Using higher sensitivity settings can help eliminate unwanted or nuisance detections.

VIA MOBILE APP (preferred)

Once the outputs are assigned, review the MOTION FIELD settings and make adjustments as necessary.

To make an adjustment, simply click and slide or click on the edit icon beside the current setting.

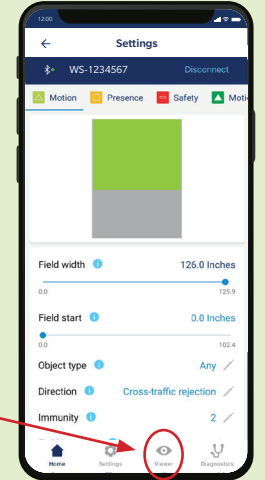
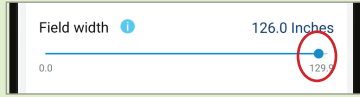

It is considered best practice to verify field dimensions in the Viewer screen.

Enable Object Display to view the relative position of objects in the field.

VIA REMOTE CONTROL

To change a setting, the remote control key sequence is as follows:

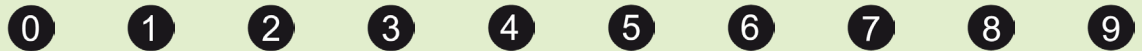
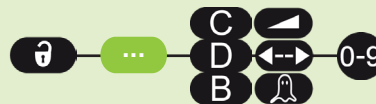

	0	1	2	3	4	5	6	7	8	9
C Field width	x x x									
D Field stop	x x x									
B Field start	x x x									
Object type								vehicle XL	vehicle	any
Direction		ANY	UNI 100%				UNI REV	UNI 100%+	UNI	
Immunity		1	2	3	4	5				

VIA LCD (not preferred)

To change a setting, see page 27 for **How To Use the LCD**, and use the following menu paths.

Main menu

Motion

Field Width: 0 – 999, default = 240.1

Field Stop: 0 – 999, default = 287.4

Object Type: any / vehicle / vehicle depth

> More

Immunity: 1 / 2 / 3 / 4 / 5

Field Start OFF: 0 – 999, default = 0.0

Direction: UNI / UNI 100%+ / UNI REV / UNI 100% / any

SETTINGS EXPLAINED

TEACH-IN

This function performs a teach-in for the designated virtual pull cord.

OBJECT TYPE

This setting offers a filtering aspect to reject detection of certain objects based on their perceived width.

Pedestrian: the sensor will only detect pedestrians and rejects larger objects such as vehicles.

Vehicle XL: the sensor will only detect large objects and rejects smaller vehicles such as bicycles and narrow forklifts.

Vehicle: the sensor will detect all vehicles no matter their size, but rejects pedestrians.

Any: the sensor detects all objects regardless of size (with respect to the typical minimum object size – see Technical Specifications, page 2).

MINIMUM PRESENCE TIME

This setting allows an object to be detected after it's present within the field within for a certain amount of time. For instance, if your minimum presence time is set to 3 seconds, an object that is present within the field for longer than 3 seconds will be detected.

To delete the virtual "Pull-Cord" zone, simply relaunch a Pull-Cord teach-in without standing in the scanning zone. After 1 minute, the sensor flashes 5x orange. Push **UNLOCK → LOCK → LOCK** to exit the adjustment mode.

MAXIMUM PRESENCE TIME

This feature is not configurable by the installer. The maximum presence time for the Presence field will dictate the maximum presence time for any pull cords that are programmed.

This setting allows an object to be detected within the field for a certain amount of time. For instance, if your max. presence time is set to 5 minutes, an object that remains within the field for longer than 5 minutes will no longer be detected.

VIA MOBILE APP (preferred)

Once the outputs are assigned, review the PRESENCE FIELD settings and make adjustments as necessary.

To make an adjustment, simply click on the edit icon beside the current setting.

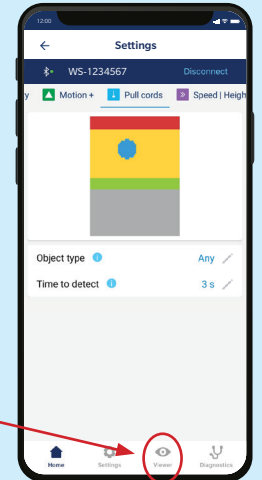

It is considered best practice to verify field dimensions in the Viewer screen.

Enable Object Display to view the relative position of objects in the field.

VIA REMOTE CONTROL

To change a setting, the remote control key sequence is as follows:

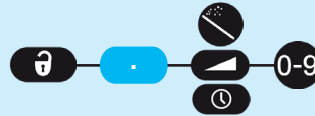

	0	1	2	3	4	5	6	7	8	9
Teach-in		#1	#2	#3						
Object type		pedestrian						vehicle XL	vehicle	any
Min. pres. time	0 sec	1 sec	2 sec	3 sec	4 sec	5 sec	6 sec	7 sec	8 sec	stop

- To create a virtual pull cord**, launch a pull cord teach-in and stand in the area you wish to create the pull cord. The LED will quickly flash red-green for 5 seconds to acknowledge your presence.
- When the teach-in process begins, **DO NOT MOVE**. The LED will slowly flash red-green to indicate that the teach-in is in progress.
- The LED will begin quickly flashing green (or stop flashing at all) when the teach-in is complete. If the LED flashes orange, refer to the Troubleshooting section to identify the error and remedy.

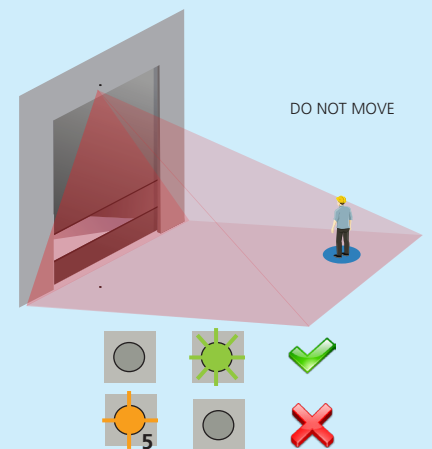

VIA LCD (not preferred)

To change a setting, see page 27 for **How To Use the LCD**, and use the following menu paths.

Via LCD, you may only program one pull-cord.

Main menu

Others

PullMinTime: 0 / 1 / 2 / 3 / 4 / 5 / 6 / 7 / 8 / 9

PullObjType: any / vehicle / vehicle depth

SETTINGS EXPLAINED

FIELD WIDTH

When facing the door, this is the measurement that extends from the center to the left and right sides equally.

FIELD STOP

When facing the door, this is the measurement (also considered depth) that extends straight out from the door.

FIELD START

When facing the door, this is the distance from the threshold that the field coverage begins (i.e. the closest part of the field to the door).

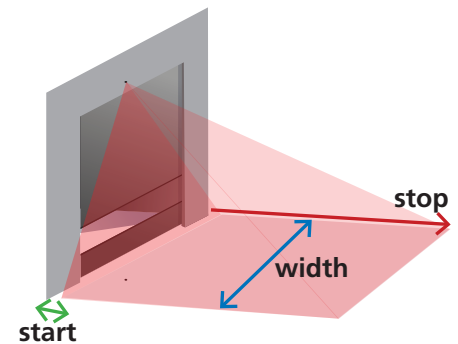

For all three of the above parameters, the maximum reachable dimensions will automatically adapt according to mounting height.

To eliminate a field, set the width or stop field to 000.

OBJECT TYPE

This setting offers a filtering aspect to reject detection of certain objects based on their perceived width.

Vehicle XL: the sensor will only detect large objects and rejects smaller vehicles such as bicycles and narrow forklifts.

Vehicle: the sensor will detect all vehicles no matter their size, but rejects pedestrians.

Any: the sensor detects all objects regardless of size (with respect to the typical minimum object size – see Technical Specifications, page 2).

MAXIMUM PRESENCE TIME

This setting allows an object to be detected within the field for a certain amount of time. For instance, if your max. presence time is set to 5 minutes, an object that remains within the field for longer than 5 minutes will no longer be detected.

Be aware that the chosen setting for the Presence field also dictates the max. presence time for any virtual pull cords.

IMMUNITY

This setting allows for increasing or reducing the sensitivity of the field for detecting an object.

Setting 1 is the most sensitive and will detect quickly.

Using higher sensitivity settings can help eliminate unwanted or nuisance detections.

VIA MOBILE APP (preferred)

Once the outputs are assigned, review the PRESENCE FIELD settings and make adjustments as necessary.

To make an adjustment, simply click and slide or click on the edit icon beside the current setting.

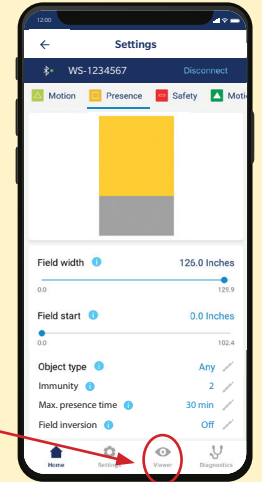

It is considered best practice to verify field dimensions in the Viewer screen.

Enable Object Display to view the relative position of objects in the field.

VIA REMOTE CONTROL

To change a setting, the remote control key sequence is as follows:

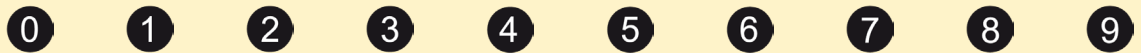
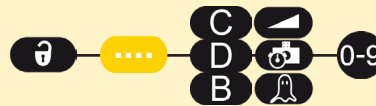

C Field width	x x x	000 (min) – 460 (max)	default = 240 in								
D Field stop	x x x	000 (min) – 460 (max)	default = 080 in								
B Field start	x x x	000 (min) – 460 (max)	default = 000 in								
Object type								vehicle XL	vehicle	any	
Max. pres. time		30 sec	1 min	2 min	5 min	10 min	30 min	60 min	120 min	infinite	
Immunity		1	2	3	4	5					

VIA LCD (not preferred)

To change a setting, see page 27 for **How To Use the LCD**, and use the following menu paths.

Main menu

Presence

Field Width: 0 – 999, default = 240.1

Field Stop: 0 – 999, default = 78.7

Object Type: any / vehicle / vehicle depth

> More

Immunity: 1 / 2 / 3 / 4 / 5

Field Start OFF: 0 – 999, default = 0.0

PresTime: Infinite / 120 min / 60 min / 30 min / 10 min / 5 min / 2 min / 1 min / 30 s

SETTINGS EXPLAINED

FIELD WIDTH

When facing the door, this is the measurement that extends from the center to the left and right sides equally.

FIELD STOP

When facing the door, this is the measurement (also considered depth) that extends straight out from the door.

For both of the above parameters, the maximum reachable dimensions will automatically adapt according to mounting height.

To eliminate a field, set field width or field stop to 000.

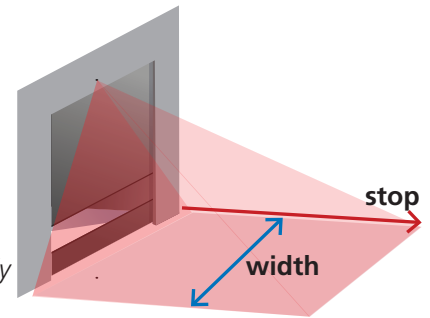

MAXIMUM PRESENCE TIME

This setting allows an object to be detected within the field within a certain amount of time. For instance, if your max. presence time is set to 5 minutes, an object that remains within the field for 10 minutes will no longer trigger detection after the first 5 minutes.

Note that within the Safety field, this feature is only applicable for objects less than 1'6" high.

Be aware that the chosen setting for the Presence field also dictates the max. presence time for any virtual pull cords.

IMMUNITY

This setting allows for increasing or reducing the sensitivity of the field for detecting an object.

Setting 1 is the most sensitive and will detect quickly.

Using higher sensitivity settings can help eliminate unwanted or nuisance detections.

UNCOVERED ZONE

This setting virtually elevates the ground to avoid detections of leaves, snow, trash, etc.

Be aware that an object smaller than the chosen value will not be detected.

VIA MOBILE APP (preferred)

Once the outputs are assigned, review the SAFETY FIELD settings and make adjustments as necessary.

To make an adjustment, simply click and slide or click on the edit icon beside the current setting.

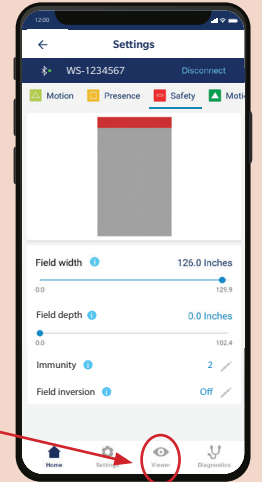
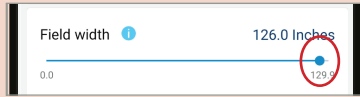

It is considered best practice to verify field dimensions in the Viewer screen.

Enable Object Display to view the relative position of objects in the field.

VIA REMOTE CONTROL

To change a setting, the remote control key sequence is as follows:



C Field width	X X X 000 (min) – 460 (max) default = 240 in									
D Field stop	X X X 000 (min) – 460 (max) default = 016 in									
📷 Max. pres. time		30 sec	1 min	2 min	5 min	10 min	30 min	60 min	120 min	infinite
🔔 Immunity		1	2	3	4	5				
F2 Uncovered zone		2"	3.9"	5.9"	9.8"	13.8"	19.7"	29.5"	39.4"	49.2"

VIA LCD (not preferred)

To change a setting, see page 27 for **How To Use the LCD**, and use the following menu paths.

Main menu

Presence

Field Width: 0 – 999, default = 240.1

Field Stop: 0 – 999, default = 15.7

> More

Immunity: 1 / 2 / 3 / 4 / 5

PresTime: Infinite / 120 min / 60 min / 30 min / 10 min / 5 min / 2 min / 1 min / 30 s

UncovZone: 49.2 / 39.4 / 29.5 / 19.7 / 13.8 / 9.8 / 5.9 / 3.9 / 2

4 ADDITIONAL SETTINGS

HEIGHT TRIGGER

When one of the outputs has been assigned Motion + Height (or output 2 is assigned Presence + Height), the Height Trigger function signals the door to open when the object is taller than the selected value and ignore an object that is shorter than the selected value.

For example, if the Height Trigger is set at 7'6", objects approaching that are shorter than 7'6" will not cause detection and objects taller than 7'6" will cause the door to open.

shorter than 7'6"



object ignored

taller than 7'6"

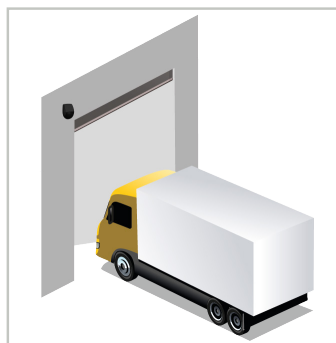

object detected

When using Height Trigger, detection occurs closer to the door.

If your application requires a partial open, see Application Note 78.6xxx for more information.

This function is not able to be modified via remote control.

VIA MOBILE APP

Navigate to the SPEED | HEIGHT screen to access Minimum Height Limit.

To change the setting, simply click on the edit icon beside the current setting.

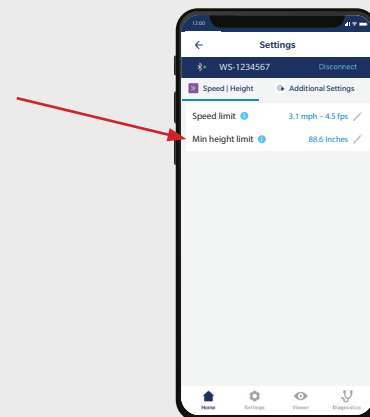

VIA LCD

To change a setting, see page 27 for **How To Use the LCD**, and use the following menu paths.

Main menu

Others

HeightMin: 157.5" / 137.3" / 127.9" / 118.1" / 108.3" / 98.4" / 88.6" (default) / 78.7" / 68.9"

NOTE: Each of these available parameters is **higher than** XX inches. I.e. If the parameter 108.4 is chosen, the sensor will detect objects with a MINIMUM height of 108.4 inches.

4 ADDITIONAL SETTINGS

SPEED TRIGGER

By default, all objects that move slower than the selected value will activate the output.

This function helps to trigger the door open in the case of late / slow-moving objects in close proximity to the door.

This function is not able to be modified via remote control.

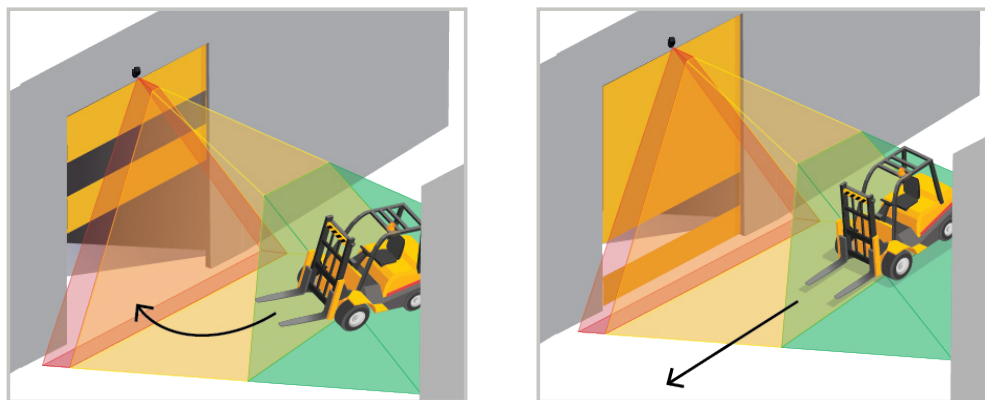

VIA MOBILE APP

Navigate to the SPEED | HEIGHT screen to access Speed Limit.

To change the setting, simply click on the edit icon beside the current setting.

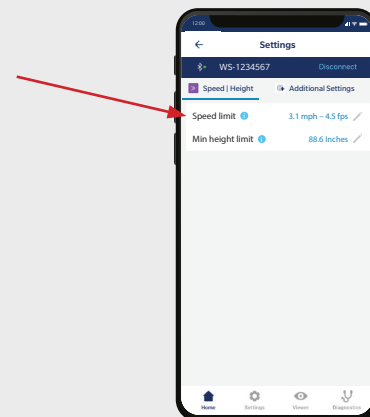

VIA LCD

To change a setting, see page 27 for **How To Use the LCD**, and use the following menu paths.

Main menu

Others

SpeedMax: 31 mph / 28 mph / 24.8 mph / 21.7 mph / 18.6 mph / 15.5 mph / 12.4 mph / 9.3 mph / 6.2 mph / 3.1 mph

NOTE: Each of these available parameters is **slower than** XX mph. I.e. If the parameter 15.5 is chosen, the sensor will detect objects moving at speeds SLOWER than 15.5 mph.

4 ADDITIONAL SETTINGS

FIELD SHIFT

This feature can be used to shift the placement of the overall field to the left or right, maximum 15.7 inches.

VIA MOBILE APP

Navigate to the ADDITIONAL SETTINGS screen to access Field Shift.

To change the setting, simply click on the edit icon beside the current setting.

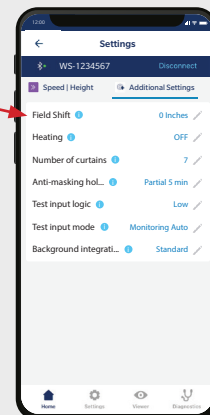

VIA REMOTE CONTROL

To change a setting, the remote control key sequence is as follows:



1	2	3	4	5	6	7	8	9
15.7"	11.8"	7.9"	3.9"	0"	3.9"	7.9"	11.8"	15.7"
shifts field to the left					shifts field to the right			

VIA LCD

To change a setting, see page 27 for **How To Use the LCD**, and use the following menu paths.

Main menu

Quick Start

> More

Lateral Offset

Note: Negative numbers shift the field to the left, positive numbers shift the field to the right.

- 0"
- 3.9"
- 7.9"
- 11.8"
- 15.7"
- 15.7"
- 11.8"
- 7.9"
- 3.9"

4 ADDITIONAL SETTINGS

HEATING FUNCTION

The sensor is equipped with a heater that warms the sensor to ensure optimal performance of the electronics and to keep the lens clear and dry.

CAUTION: The sensor draws considerably more power (increase to 1.25 A @ 12 VDC / 0.625 A @ 24 VDC) with the heating function ON. Reference the Technical Specifications to ensure you have enough available power.

This function is not able to be modified via remote control.

VIA MOBILE APP

Navigate to the ADDITIONAL SETTINGS screen to access Heating.

To change the setting, simply click on the edit icon beside the current setting.

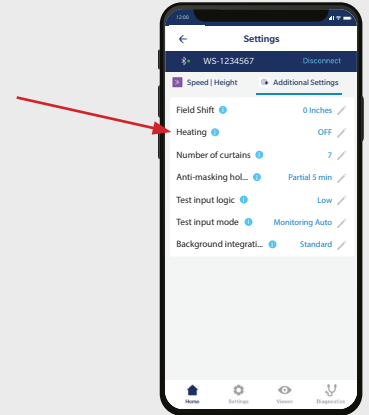

VIA LCD

To change a setting, see page 27 for **How To Use the LCD**, and use the following menu paths.

Main menu

Quick Start

> More

Heating: auto / eco / off (default)



The following additional settings available in the mobile app or LCD menus should only be used under BEA advisement for troubleshooting purposes:

- Presettings
- Number of curtains
- Antimasking hold time
- Test input logic
- Test input mode
- Background integration

5 FINISH

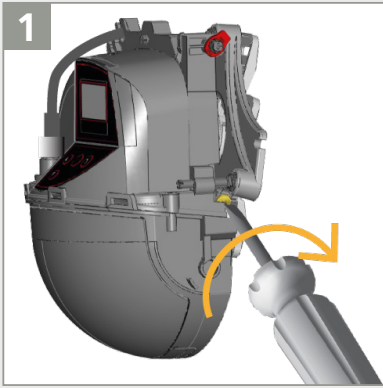

1 Lock the sensor position by firmly fastening the angle lock screw.

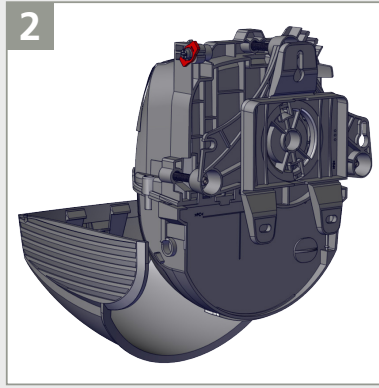



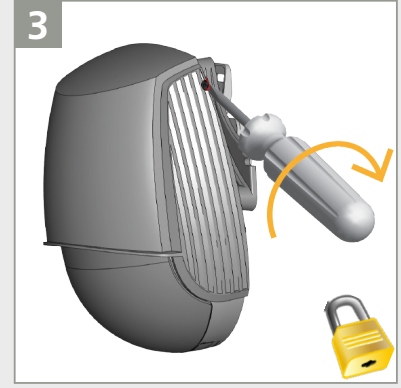

2 Reclip the sensor cover **horizontally** (as shown) and close it.



3 Lock the cover by turning the lock screw clockwise.

TROUBLESHOOTING

	N	EEPROM / Watchdog test	Cycle power. If error returns, replace sensor.
E1 	E1: CPU-XXX	The sensor encounters an internal problem	Cycle power. If error returns, replace sensor.
E2 	E2: XXX PWR	The ADP supply is faulty	Cycle power. If error returns, replace sensor.
		The LZR supply is faulty	1. Check power supply (Diagnostics menu in LCD) to ensure it is within specified range. 2. Cycle power. If error returns, replace sensor.
		The 5V supply is faulty	1. Check power supply (Diagnostics menu in LCD) to ensure it is within specified range. 2. Cycle power. If error returns, replace sensor.
	E2: IN SUPPLY	The power supply is too low or too high	1. Check power supply (Diagnostics menu in LCD) to ensure it is within specified range. 2. Cycle power. If error returns, replace sensor.
	E2: TEMP	The internal temperature is too low or too high	Check the sensor temperature (Diagnostics menu in LCD) to ensure it is within specified range.
			1. Check power supply (Diagnostics menu in LCD) to ensure it is within specified range. 2. Cycle power. If error returns, replace sensor.
			Set Heating mode to "auto."
			Protect the sensor from direct exposure to heat or cold.
	E3: RXTX PWM	DCA Communication error	Contact BEA Technical Support.
	E4: FRONTFACE	Front face masking	Remove blue protection film.
			Ensure the cover is either completely removed or latched in the closed position.
			Clean the sensor lens with appropriate material.
			Check for frost/ice on the lens. Use Heating function, if necessary.
			Ensure no object (goal post, low ceiling, etc.) is obstructing the sensor view.
E5 		The sensor requires a teach-in	Launch teach-in after angle adjustment. All presence/safety outputs are activated.
	E5: INSTALL	Install teach-in is required after power-on, curtain disabling, or factory reset	Launch a teach-in.
	E5: FLATNESS	Faulty teach-in because the sample area is not flat	1. Make sure that the teach-in zone is clear of objects. 2. Make sure that any drains/washouts (i.e. holes) are covered with cardboard. 3. Launch an install teach-in. Or launch an Install Right or Install Left teach-in if objects are permanent and unmovable, yet still obstructing a successful teach-in.
	E5: MASKING	A portion of the sensor's view is blocked during the Install Teach-in	1. Determine if the masked area will affect sensor performance (think "If I can't see it, it can't see me"). 2. Walk-test the patterns to ensure good detection and operation.
	E5: TILT	Faulty teach-in due to tilt angle (i.e. tilted too far away from or too close to the door)	1. Adjust tilt angle (Diagnostics menu in LCD). Note: max. 15° 2. Launch an install teach-in.
			Change Force Tilt from "auto" to "manual."
	E5: AZIMUTH	Faulty teach-in due to lateral angle (i.e. rotated too far clockwise or counter-clockwise on the bracket)	1. Adjust lateral angle (Diagnostics menu in LCD). Note: max. 45° Launch an install teach-in.
	Change Force Azimuth from "auto" to "manual."		
E5: HEIGHT	Faulty teach-in due to mounting height	Adjust mounting height (max. 32', min. 6'6").	
		Launch install teach-in.	

Troubleshooting continues on next page...

TROUBLESHOOTING

E5 	E5: TIME-OUT	Fault teach-in	Relaunch install teach-in. Make sure that there is no motion detection during at least 5 seconds when LED starts flashing red/green. Slightly change your position and relaunch an install teach-in.
	E5: FORCED	Tilt angle, azimuth angle, or height has been manipulated	Nothing; this is a notification that the tilt angle, azimuth angle, or height has not been automatically calculated by the sensor.
E6 	E6: FQ OUT	Faulty sensor output 1	Replace sensor.
E8 	E8: ...	Faulty detection engine	Cycle power. If error returns, replace sensor.
	Solid ORANGE LED remains on	The sensor encounters a memory problem	Replace sensor.
 3 sec	ORANGE LED is on for 3 sec. (masking)	Sensor placed in a corner and perpendicular to a wall	Tilt sensor to shift detection field. Ignore warning:  
		Masking: obstacle high up in front of door	Reduce number of curtains (QUICK START > MORE > Nb curtains). Ignore warning:  
Door does not react	Service mode is activated	Service mode is activated	Exit service mode (see page 9).
		Incorrect outputs (if occurring in Motion field, it is likely that Motion+Height is selected)	Check output functions and adjust accordingly.
		Incorrect wiring	Verify wiring.
		Incorrect door control programming	Contact door manufacturer.
Sensor does not react to remote control	Sensor is password-protected	Enter correct password. If you forgot the code, cut and restore power supply in order to access the sensor without entering a password during 1 minute.	
Motion detection starts too late	Negative angle is too large	Reduce angle of the sensor.	



Can't find your answer? Visit [BEAsensors.com](https://www.BEAsensors.com) or scan QR code for Frequently Asked Questions!

Before contacting BEA Technical Support, locate the serial and CAN numbers of your sensor.

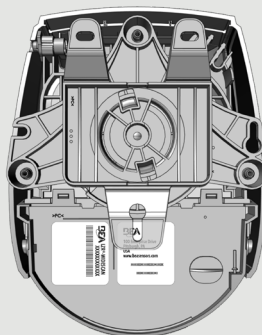

SERIAL NUMBER

view: back of sensor

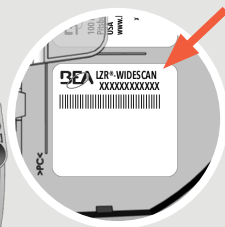

CAN NUMBER

view: top of sensor

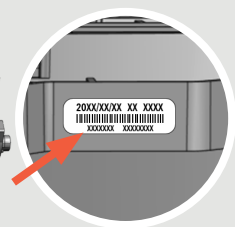

APPENDIX A

HOW TO USE THE LCD



OK
SHORT PRESS
Enter the LCD menu.
Select a folder, parameter, or value.
Confirm a value and exit edit mode.

Return
Return to previous menu or display.

OK
PRESS 2X
Activate red spots on floor.

Up Arrow
Scroll up or down.

OK
LONG PRESS
Launch POSITION WIZARD.

Down Arrow
Press and hold to adjust screen brightness.



Select your **Language** before entering the first LCD menu.
Within the first 30 seconds of power-on of the sensor or later in the diagnostics menu.



Enter a **Password** if necessary.



Access advanced adjustments.



Go to the **Diagnostics** menu.

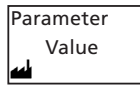

Displayed value = Factory value

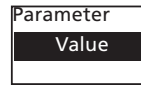

Displayed value = Saved value

HOW TO USE THE REMOTE CONTROL



After unlocking, the red LED flashes and the sensor can be adjusted by remote control.



If the red LED flashes quickly after unlocking, enter an access code from 1 to 4 digits. If you do not know the access code, **cycle power**.



To end an adjustment session, always lock the sensor.

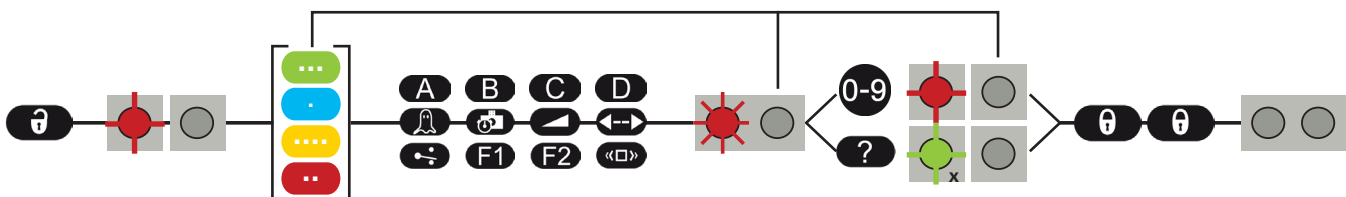

If necessary, select the corresponding detection field before selecting the parameter and changing the value. The second LED indicates the detection field.

x = number of flashes = value of parameter

2x 1x 3x 1x 5x = field width 2.35m

HOW TO USE THE REMOTE CONTROL

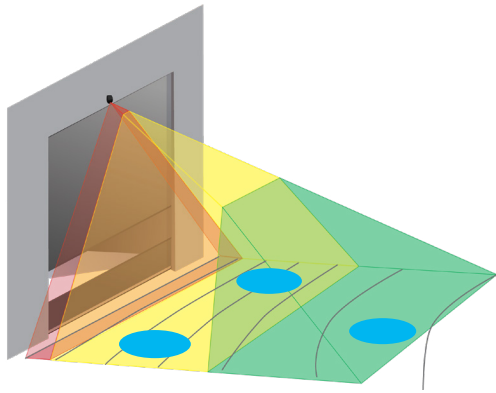

- MOTION
- PRESENCE
- PULL-CORD
- SAFETY

Without selecting a color key, all 3 detection field widths (motion, presence, safety) are adjusted at the same time.

To save an access code via the remote control:

To delete an access code via the remote control:

Enter the existing code
 If the access code is unknown, cycle power to delete the existing access code. For the first minute, you can access the sensor without an access code.

QUICK REFERENCE - COMMON KEY SEQUENCES:

- Activate red spots on floor
- Teach-in: install
- Teach-in: pull-cord / /
- Restoring /

TEACH-IN: WALK

You can also reshape one or more detection fields by walking around the requested field (steps 1 – 3). It is possible to cut into the existing field from the border or to extract a field within the detection field (step 4).



Make sure the field is larger than desired. The existing field size can be reduced and adapted, but cannot exceed the configured size.

1 LAUNCH A WALK TEACH-IN

Choose the desired field(s) by LCD or remote control:

	LEFT LED	
Quick Start > TeachIn > Walk All: Motion, Presence, and Safety field		
Quick Start > TeachIn > Walk Motion: Motion field only		
Quick Start > TeachIn > Walk Presence: Presence field only		
Quick Start > TeachIn > Walk Safety: Safety field only		

2 GO TO STARTING POINT

60 SEC / 5 SEC

Step away from the detection field and remove any objects (ladder, tools etc).

Go to the starting position of your detection field (see 1st picture below).

The delay after which the teach-in is launched is 60 seconds by LCD (adjustable to 30 or 120 sec via Quick Start > More > TeachInDelay). **The delay by remote control is 5 seconds.**



3 DO NOT MOVE

The sensor learns its background as long as the LED flashes red-green.

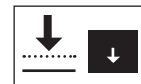

continued on next page...

4 START WALKING

When LED flashes green, hold one arm in the air and slowly start walking the trace of the desired field shape. Then, stop and wait until LED stops flashing.



CUT-OUT

START outside of the max. detection field.
STOP outside the max. detection field.

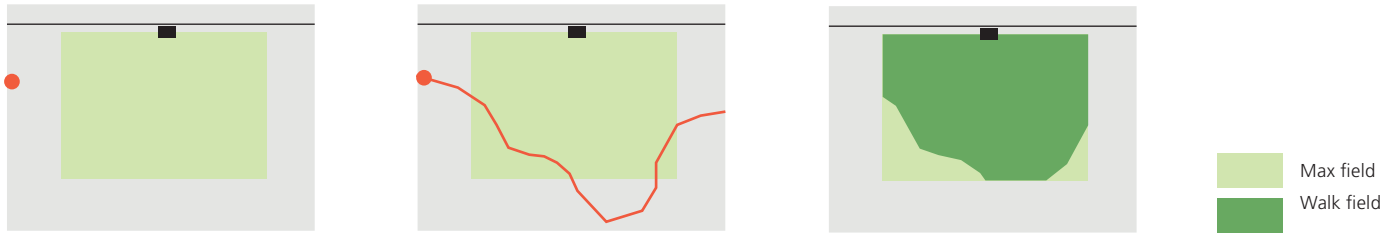

EXTRACT

START anywhere in the max. detection field.
STOP close to the starting point.

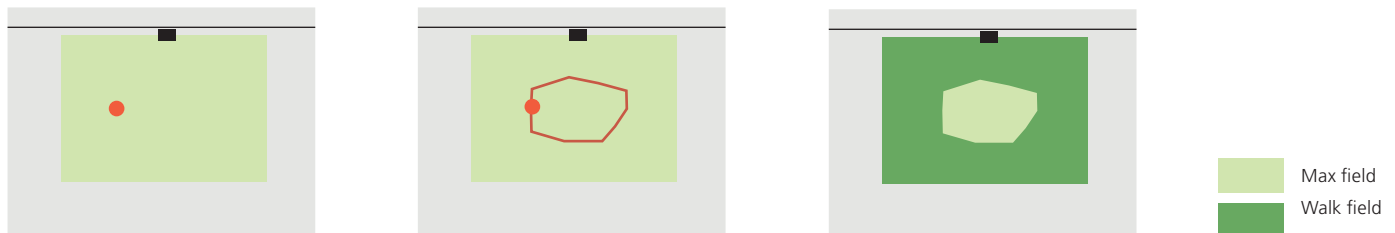

The teach-in was either successful or not (see TROUBLESHOOTING).



ADD TRACE / INVERT FIELD:

Using the remote control, you can add a trace of the field shape to all fields or one in particular (step 1).

You can invert each detection field (i.e. make the inactive side of the walked trace active) via LCD (Motion/Presence/Safety > More > Field inversion) or remote control. See image to the right for inversion of the field pictured above (bottom right). This feature is only available after a walk teach-in; standard setting will not allow for field inversion.

Always verify the field dimensions via the Field Display option on the LCD screen (Diagnostics > FieldDisplay).

To delete a trace, simply relaunch a walk teach-in and clear the respective detection zone for 15 seconds.

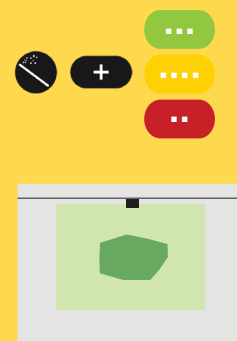

APPENDIX B

Accessories and Replacements Parts

ACCESSORIES



10INDBRACKET
Industrial mounting bracket



10MINIBRACKET
Short adjustable mounting bracket



10.1311
LZR-WIDESCAN adapter kit *



10WBA
Universal mounting bracket arm



10WBAMOUNT
Universal mounting bracket plate



10REMOTE
Universal remote control



35.1555
Power cable, 50 ft.

* required for use with Industrial Bracket and Mini Bracket

REPLACEMENT PARTS



35.0245
Replacement cover for LZR-WIDESCAN



41.8838
Replacement base for LZR-WIDESCAN



35.1554
Power cable, 30 ft.

BEA, INC. INSTALLATION/SERVICE COMPLIANCE EXPECTATIONS

BEA, Inc., the sensor manufacturer, cannot be held responsible for incorrect installations or incorrect adjustments of the sensor/device; therefore, BEA, Inc. does not guarantee any use of the sensor/device outside of its intended purpose.

BEA, Inc. strongly recommends that installation and service technicians be AAADM-certified for pedestrian doors, IDA-certified for doors/gates, and factory-trained for the type of door/gate system.

Installers and service personnel are responsible for executing a risk assessment following each installation/service performed, ensuring that the sensor/device system performance is compliant with local, national, and international regulations, codes, and standards.

Once installation or service work is complete, a safety inspection of the door/gate shall be performed per the door/gate manufacturer's recommendations and/or per AAADM/ANSI/DASMA guidelines (where applicable) for best industry practices. Safety inspections must be performed during each service call – examples of these safety inspections can be found on an AAADM safety information label (e.g. ANSI/DASMA 102, ANSI/DASMA 107, UL294, UL325, and International Building Code).

Verify that all appropriate industry signage, warning labels, and placards are in place.

